

100W isolated DC-DC converter
Wide input and regulated single output

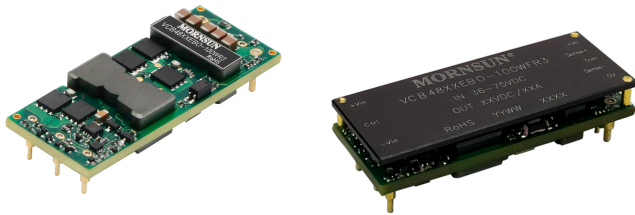

Patent Protection RoHS



FEATURES

- Wide input voltage range: 36-75 VDC
- High efficiency up to 93%
- I/O Isolation test voltage 1.5K VDC
- Operating ambient temperature range: -40°C to +100°C
- Input under-voltage protection, output short circuit, over-current, over-voltage protection, over-temperature protection
- Industry standard package: 1/8 brick
- Meet IEC/UL/EN62368 standard

VCB48_EBO-100W(F)R3 series of isolated 100W DC-DC converter products with an wide 2:1 input voltage range. They feature efficiencies up to 93%, input to output isolation is tested with 1500VDC and the converter safely operate ambient temperature of -40°C to +100°C, input under-voltage protection, output over-voltage, over-current, short-circuit protection, over-temperature protection. They are ideally and widely used in applications such as industrial control, electric power, instruments and communications.

Selection Guide

Certification	Part No. ①	Input Voltage (VDC)		Output		Full Load Efficiency ^③ (%) Min./Typ.	Capacitive Load (μF)Max.
		Nominal (Range)	Max. ^②	Voltage (VDC)	Current(A) Max./Min.		
--	VCB4805EBO-100W(F)R3	48 (36-75)	75	5	20/0	90/92	6000
	VCB4812EBO-100W(F)R3	48 (36-75)	75	12	8.3/0	91/93	2000
	VCB4815EBO-100W(F)R3	48 (36-75)	75	15	6.67/0	91/93	2000
	VCB4824EBO-100W(F)R3	48 (36-75)	75	24	4.17/0	90/92	1000
	VCB4828EBO-100W(F)R3	48 (36-75)	75	28	3.57/0	90/92	1000

Notes:
 ① Use "F" suffix for heat sink mounting. We recommend to choose modules with a heat sink for enhanced heat dissipation and applications with extreme temperature requirements;
 ② Exceeding the maximum input voltage may cause permanent damage;
 ③ Efficiency is measured in nominal input voltage and rated output load.

Input Specifications

Item	Operating Conditions	Min.	Typ.	Max.	Unit
Input Current (full load / no-load)	Nominal input voltage	--	2264/20	2315/30	mA
Reflected Ripple Current		--	30	100	
Surge Voltage (1sec. max.)		-0.7	--	80	VDC
Start-up Voltage		--	--	36	VDC
Start-up Current		--	--	5	A
Input Under-voltage Protection		26	29	--	VDC
Start-up Time	Nominal input voltage & constant resistance load	--	--	100	ms
Input Filter		π filter			
Hot Plug		Unavailable			
Ctrl ^①	Module on	Ctrl pin open or pulled high (TTL 3.5-12VDC)			
	Module off	Ctrl pin pulled low to GND (0-1.2VDC)			
	Input current when off	--	3	10	mA

Note: ①The Ctrl pin voltage is referenced to input GND.

Output Specifications

Item	Operating Conditions	Min.	Typ.	Max.	Unit	
Voltage Accuracy	0%-100% load	--	±1	±3	%Vo	
Linear Regulation	Input voltage variation from low to high at full load	--	±0.2	±0.5		
Load Regulation	5%-100% load	--	±0.5	±0.75		
Transient Recovery Time	25% load step change	--	300	500	μs	
Transient Response Deviation	25% load step change	5V output	--	±5	±8	%Vo
		Others	--	±3	±5	%Vo
Temperature Coefficient	Full load	--	--	±0.03	%/°C	
Ripple & Noise ^①	20MHz bandwidth, nominal input voltage, 5%-100% load	--	100	150	mVp-p	
Trim		90	--	110	%Vo	
Sense		--	--	105		
Over Temperature	Product surface max. temperature	--	130	--	°C	
Over-voltage Protection	Input voltage range	110	--	160	%Vo	
Over-current Protection		110	140	190	%Io	
Short-circuit Protection		Continuous, self-recovery, time ≤ 3 seconds				

Note: ①The "Tip and barrel" method is used for ripple and noise test, please refer to *DC-DC Converter Application Notes* for specific information. Ripple & Noise at <5% load is 5%Vo max.

General Specifications

Item	Operating Conditions	Min.	Typ.	Max.	Unit
Isolation	Input-output Electric Strength Test for 1 minute with a leakage current of 1mA max.	1500	--	--	VDC
Insulation Resistance	Input-output resistance at 500VDC	1000	--	--	MΩ
Isolation Capacitance	Input-output capacitance at 100KHz/0.1V	--	1000	--	pF
Operating Temperature	See temperature derating curve	-40	--	+100	°C
Storage Temperature		-55	--	+125	
Storage Humidity	Non-condensing	5	--	95	%RH
Pin Soldering Resistance Temperature	Wave soldering, 10 seconds	--	--	+260	°C
	Soldering spot is 1.5mm away from case for 10 seconds	--	--	+300	
Shock and Vibration Test		10-55Hz, 10G, 30Min. along X, Y and Z			
Switching Frequency ^①	PWM mode	--	200	--	KHz
Altitude		Altitude: ≤2000m, Atmospheric pressure: 80~110KPa			
MTBF	MIL-HDBK-217F@25°C	500	--	--	K hours

Note: ①Switching frequency is measured at full load. The module reduces the switching frequency for light load (below 50%) efficiency improvement.

Mechanical Specifications

Dimensions	VCB48_EBO-100WR3	58.42 x 22.86 x 9.69mm
	VCB48_EBO-100WFR3	58.42 x 22.86 x 12.7mm
Weight	VCB48_EBO-100WR3	27.0g (Typ.)
	VCB48_EBO-100WFR3	35.9g (Typ.)
Cooling method	Natural convection or forced air convection	

Electromagnetic Compatibility (EMC)

Emissions	CE	CISPR32/EN55032 circuit)	CLASS A (see Fig.3 for recommended circuit)/CLASS B (see Fig.4 for recommended circuit)	
	RE	CISPR32/EN55032 circuit)	CLASS A (see Fig.3 for recommended circuit)/CLASS B (see Fig.4 for recommended circuit)	
Immunity	ESD	IEC/EN61000-4-2	Contact ±6KV	perf. Criteria B
	RS	IEC/EN61000-4-3	10V/m	perf. Criteria A
	EFT	IEC/EN61000-4-4	±2KV (see Fig.3 for recommended circuit)	perf. Criteria B
	Surge	IEC/EN61000-4-5	line to line ±2KV (see Fig3 for recommended circuit)	perf. Criteria B
	CS	IEC/EN61000-4-6	3 Vr.m.s	perf. Criteria A

Temperature Derating Curve

VCB4805EBO-100WR3 (Vin=48V)

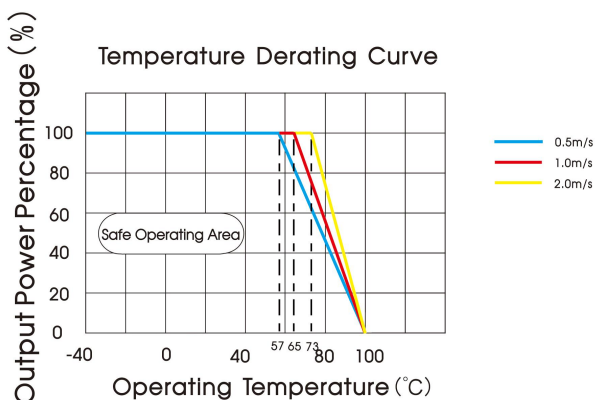

VCB4812EBO-100WR3 (Vin=48V)

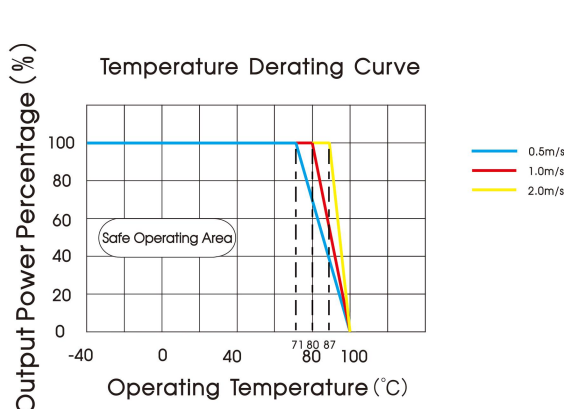

VCB4815EBO-100WR3 (Vin=48V)

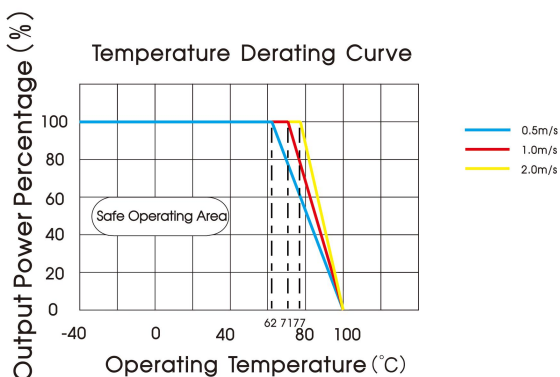

VCB4824EBO-100WR3 (Vin=48V)

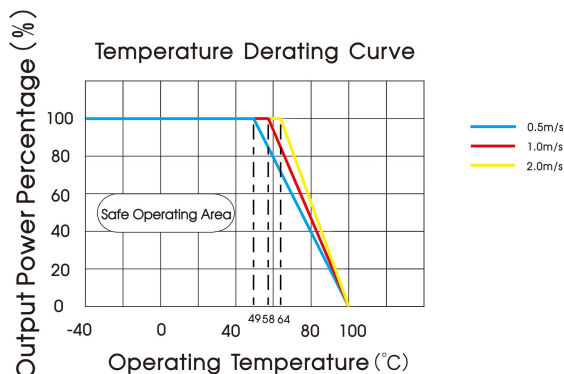

VCB4828EBO-100WR3 (Vin=48V)

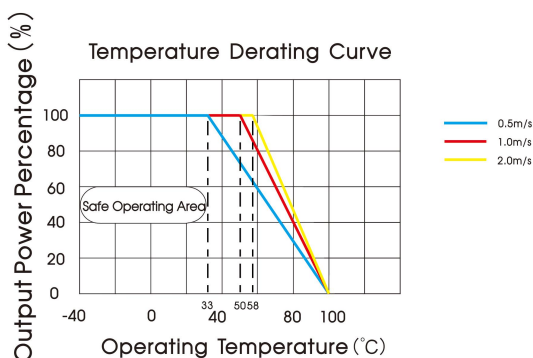

VCB4805EBO-100WFR3 Temperature Derating Curves

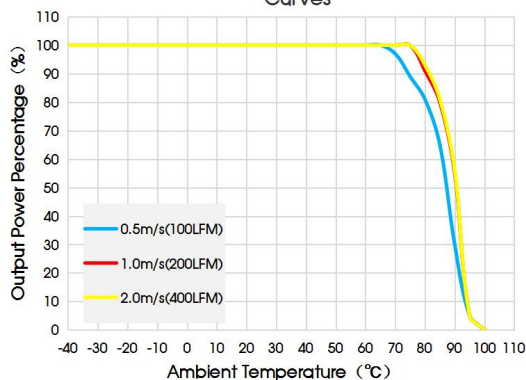

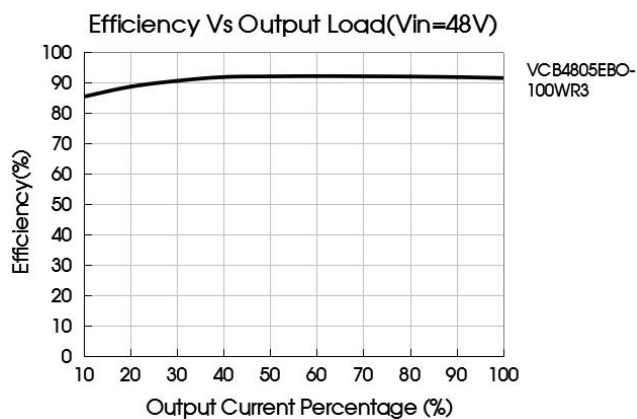
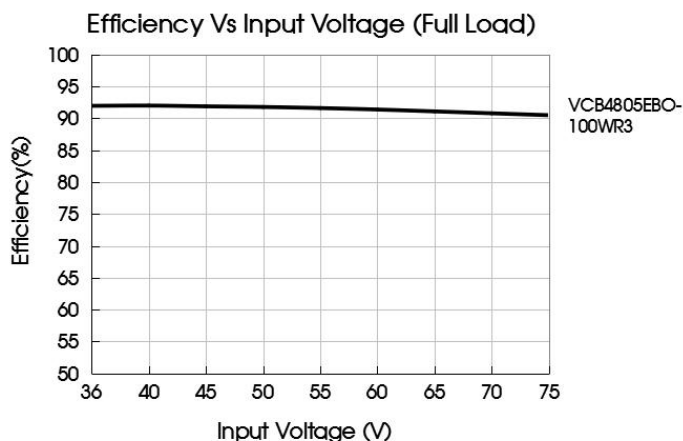
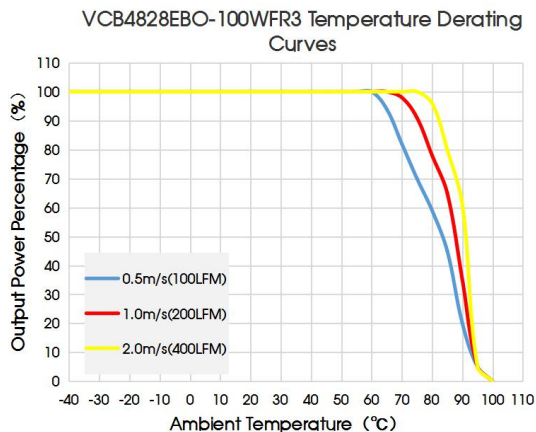
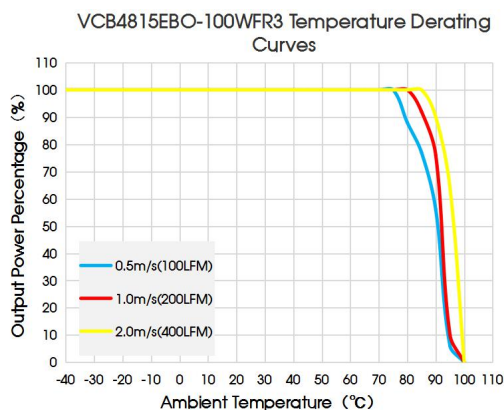

Remote Sense Application

1. Remote Sense Connection if not used

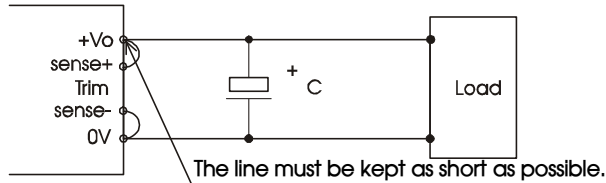

Notes:

- (1) If the sense function is not used for remote regulation the user must connect the +Sense to +Vo and -Sense to 0V at the DC-DC converter pins and will compensate for voltage drop across pins only.
- (2) The connections between Sense lines and their respective power lines must be kept as short as possible, otherwise they may be picking up noise, interference and/or causing unstable operation of the power module.

2. Remote Sense Connection used for Compensation

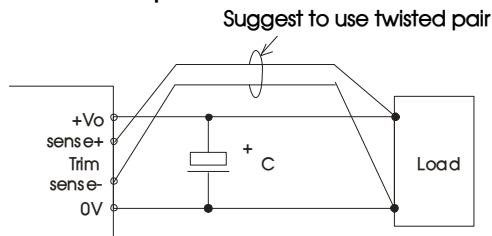

Notes:

- (1) Using remote sense with long wires may cause unstable output, please contact technical support if long wires must be used.
- (2) PCB-tracks or cables/wires for Remote Sense must be kept as short as possible. Twisted pair or shielded wires are suggested for remote compensation and must be kept as short as possible.
- (3) We recommend using adequate cross section for PCB-track layout and/or cables to connect the power supply module to the load in order to keep the voltage drop below 0.3V and to make sure the power supply's output voltage remains within the specified range.
- (4) Note that large wire impedance may cause oscillation of the output voltage and/or increased ripple. Consult technical support or

factory for further advice of sense operation.

Design Reference

1. Ripple & Noise

All the DC-DC converters of this series are tested before delivery using the recommended circuit shown in Fig. 1.

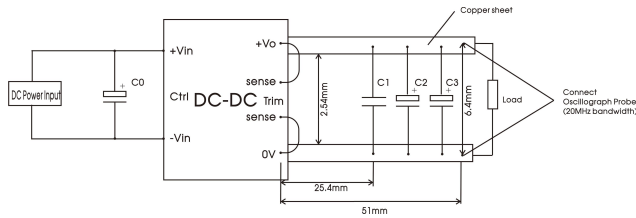

Fig. 1

Capacitors value	C0	C1	C2	C3
Output voltage				
5VDC	100uF/100V	1uF/50V	10uF/50V	330uF/63V
12VDC				
15VDC				
24VDC				
28VDC				

2. Typical application

We recommended using Mornsun's EMC circuit, otherwise please ensure that at least a 100µF electrolytic capacitors is connected at the input in order to ensure adequate voltage surge suppression and protection.

Input and/or output ripple can be further reduced by appropriately increasing the input & output capacitor values Cin and Cout and/or by selecting capacitors with a low ESR (equivalent series resistance). Also make sure that the capacitance is not exceeding the specified max. capacitive load value of the product.



Fig. 2

Capacitors value	Cin	Cout
Output voltage		
5VDC	100uF/100V	330uF/63V
12VDC		
15VDC		
24VDC		
28VDC		

3. EMC compliance recommended circuit

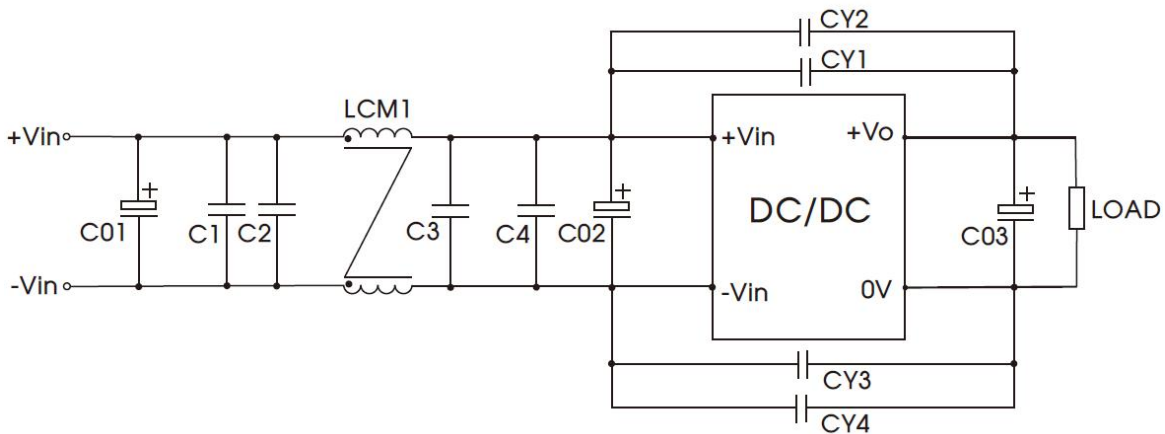

Fig. 3

C01	470uF/100V (electrolytic capacitor)
C02	100uF/100V (electrolytic capacitor)
C03	330uF/63V (electrolytic capacitor)
C1, C2, C3, C4	4.7uF/100V
CY1, CY2, CY3, CY4	2.2nF/2KV
LCM1	2mH, recommended to use MORNSUN P/N: FL2D-A2-202(C)

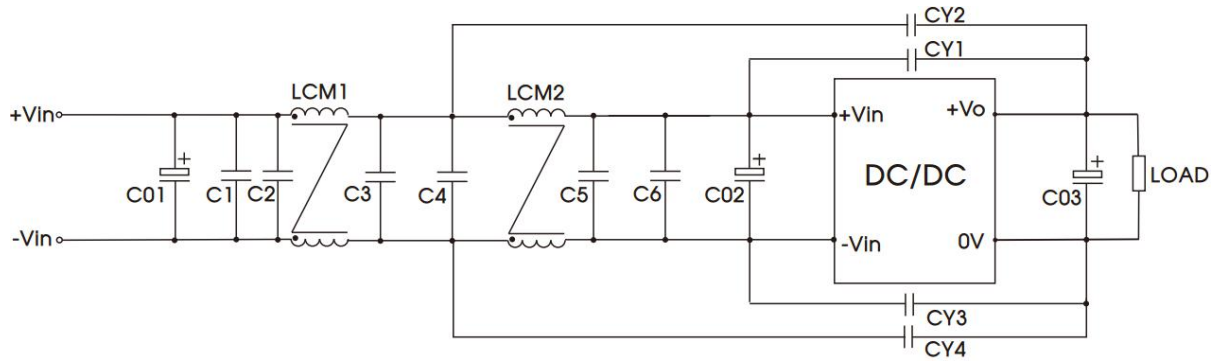
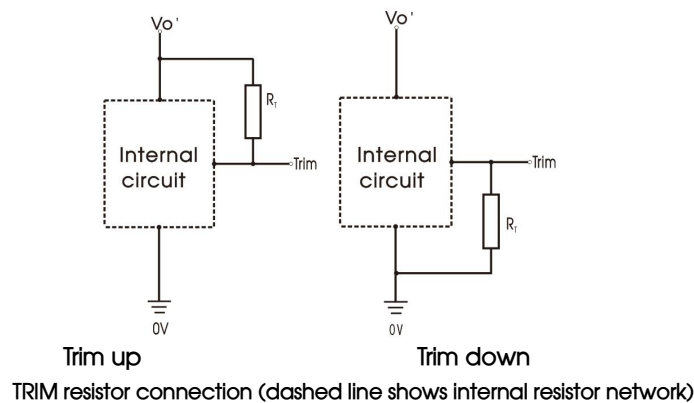

Fig. 4

C01	470uF/100V (electrolytic capacitor)
C02	100uF/100V (electrolytic capacitor)
C03	330uF/63V (electrolytic capacitor)
C1, C2, C3, C4, C5, C6	4.7uF/100V
CY1, CY2, CY3, CY4	4.7nF/1.5KV
LCM1, LCM2	2.0mH, recommended to use MORNSUN P/N: FL2D-A2-202(C)

4. Trim Function for Output Voltage Adjustment (open if unused)



Calculating Trim resistor values:

Trim up

$$R_T = \left(\frac{5.11V_{nom}(100 + \Delta\%)}{1.225\Delta\%} - \frac{511}{\Delta\%} - 10.22 \right) (k\Omega)$$

Trim down

$$R_T = \left(\frac{511}{\Delta\%} \right) - 10.22 (k\Omega)$$

Note:

RT = Trim Resistor value

$$\Delta\% = \left| \frac{V_{nom} - V_{out}}{V_{nom}} \right| \times 100$$

V_{nom} = nominal output voltage

V_{out} = desired output voltage

When the output voltage is 12V, the up-regulated voltage is +10%, that is, the output voltage set to 13.2V:

$$\Delta\% = \left| \frac{12 - 13.2}{12} \right| * 100 = 10 \quad R_T = \frac{5.11 * 12 * (100 + 10)}{1.225 * 10} - \frac{511}{10} - 10.22 = 489K\Omega$$

When the output voltage is 12V, the down-regulated voltage is -10%, that is, the output voltage set to 10.8V:

$$\Delta\% = \left| \frac{12-10.8}{12} \right| * 100 = 10 \quad R_T = \frac{511}{10} - 10.22 = 40.88K\Omega$$

5. Hot Test Point

The thermal element is installed on the top surface of the product and dissipates heat to the surrounding environment through conduction, convection and radiation. Sufficient heat dissipation conditions should be provided to ensure the reliable operation of the product.

By measuring the temperature of the thermal test point ① in Fig. 5, it can be verified whether the heat dissipation conditions are met.

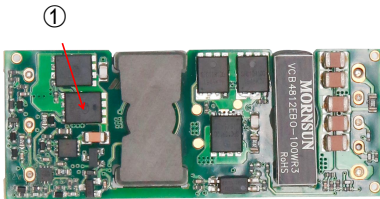

Note:

The temperature of the hot test point ① cannot exceed 130°C, otherwise the product will trigger protection due to excessive temperature and cannot work normally.

6. The products do not support parallel connection of their output

7. For additional information please refer to DC-DC converter application notes on www.mornsun-power.com

VCB48_EBO-100WR3 Dimensions and Recommended Layout

THIRD ANGLE PROJECTION 

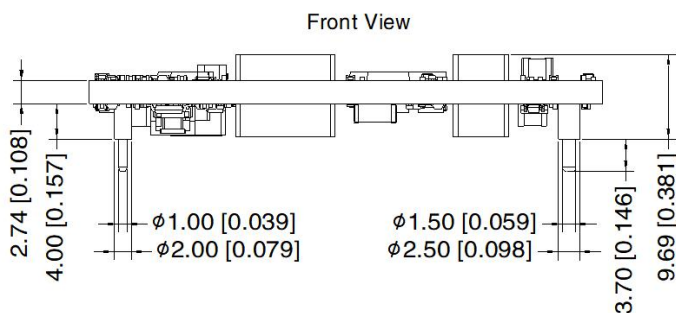
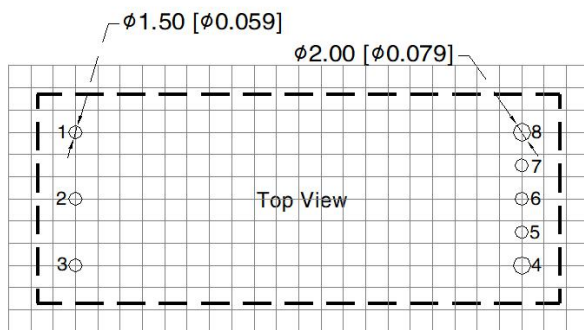
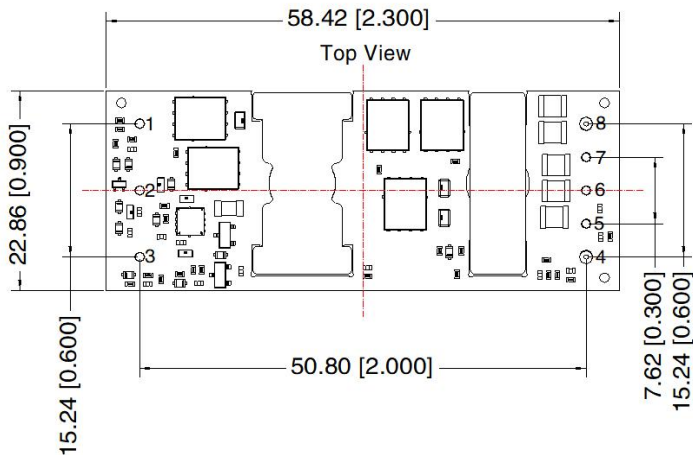

Pin-Out	
Pin	Function
1	+Vin
2	Ctrl
3	-Vin
4	0V
5	-Sense
6	Trim
7	+Sense
8	+Vo

Note:
Unit: mm[inch]
Pin section tolerances: ± 0.10 [± 0.004]
General tolerances: ± 0.50 [± 0.020]
PIN1/2/3/5/6/7: $\phi 1.0$ mm; PIN4/8: $\phi 1.5$ mm
The layout of the device is for reference only, please refer to the actual product

VCB48_EBO-100WFR3 Dimensions and Recommended Layout

THIRD ANGLE PROJECTION 

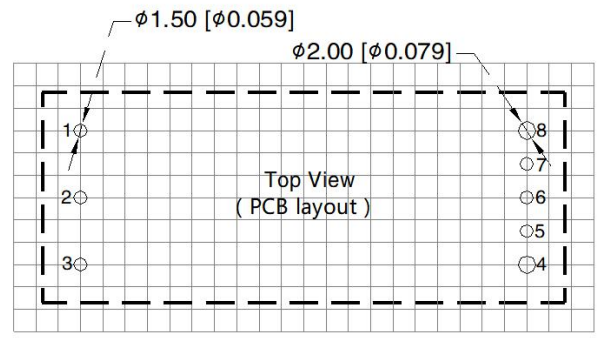
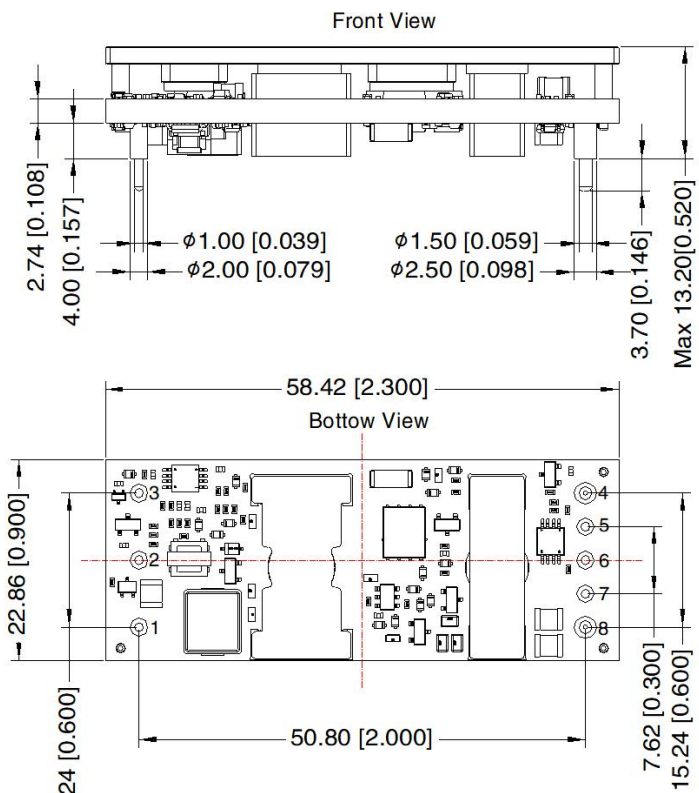

Note: Grid 2.54*2.54mm

Pin-Out	
Pin	Function
1	+Vin
2	Ctrl
3	-Vin
4	0V
5	-Sense
6	Trim
7	+Sense
8	+Vo

Note:
Unit: mm[inch]
Pin section tolerances: $\pm 0.10 [\pm 0.004]$
General tolerances: $\pm 0.50 [\pm 0.020]$
PIN1/2/3/5/6/7: $\phi 1.0\text{mm}$; PIN4/8: $\phi 1.5\text{mm}$
The layout of the device is for reference only, please refer to the actual product

Note:

- For additional information on Product Packaging please refer to www.mornsun-power.com. Packaging bag number: 58210119(VCB48_EBO-100WR3), 58210152(VCB48_EBO-100WFR3);
- The maximum capacitive load offered were tested at input voltage range and full load;
- Unless otherwise specified, parameters in this datasheet were measured under the conditions of $T_a=25^\circ\text{C}$, humidity<75%RH with nominal input voltage and rated output load;
- All index testing methods in this datasheet are based on company corporate standards;
- We can provide product customization service, please contact our technicians directly for specific information;
- Products are related to laws and regulations: see "Features" and "EMC";
- Our products shall be classified according to ISO14001 and related environmental laws and regulations, and shall be handled by qualified units.

Mornsun Guangzhou Science & Technology Co., Ltd.

Address: No. 5, Kehui St. 1, Kehui Development Center, Science Ave., Guangzhou Science City, Huangpu District, Guangzhou, P. R. China
Tel: 86-20-38601850 Fax: 86-20-38601272 E-mail: info@mornsun.cn www.mornsun-power.com