

AC/DC Converter

PVA70-27Bxx Series

MORNSUN®

70W isolated AC-DC converter with ultra-wide, ultra-high 85 - 900VAC input for coalmine



RoHS

FEATURES

- Specially designed for electrical equipment in coal mining industry
- Ultra-wide 85 - 900VAC input voltage range
- Industrial grade operating temperature: -25°C to +70°C
- High I/O isolation test voltage of 4000VAC
- High reliability, high efficiency, long lifespan
- Output short circuit, over-current and over-voltage protection
- Immunity, EFT/Surge: ±4KV perf. Criteria B

PVA70-27Bxx series is a special power supply designed for customers who provide electrical equipment for coal mining industry to meet the requirements of safety in providing power supply, easy mounting and technology innovation etc. It features ultra-wide input voltage range from 85 to 900VAC which covers 127/220/380/660VAC used in coal mining industry, high isolation voltage, excellent EMS performance, multiple protections and high efficiency. They are widely used in monitoring and security sectors of coal mining industry.

Selection Guide

Part No.	Output Power	Nominal Output Voltage and Current (Vo/Io)	Efficiency at 330VAC (%) Typ.	Capacitive Load (µF) Max.
PVA70-27B24	70W	24V/2917mA	87	800
PVA70-27B28	70W	28V/2500mA	87	800
PVA70-27B35	70W	35V/2000mA	87	800

Input Specifications

Item	Operating Conditions	Min.	Typ.	Max.	Unit
Input Voltage Range	AC input	85	--	900	VAC
Input Frequency		47	--	63	Hz
Input Current	127VAC	--	--	1.20	A
	330VAC	--	--	0.80	
	660VAC	--	--	0.50	
Inrush Current	330VAC	--	80	--	
	660VAC	--	140	--	
	900VAC	--	180	--	
External input Fuse		3.5A/1000VAC, required			
Hot Plug		Unavailable			

Output Specifications

Item	Operating Conditions	Min.	Typ.	Max.	Unit	
Output Voltage Accuracy	All load range	--	±2	--	%	
Line Regulation	Rated load	--	±0.5	--		
Load Regulation	10% - 100% load	--	±1	--		
Ripple & Noise*	20MHz bandwidth (peak-to-peak value)	24V/28V output	--	100	200	mV
		35V output	--	--	150	
Temperature Coefficient		--	±0.02	--	%/°C	
Short Circuit Protection		Hiccup, continuous, self-recovery				
Over-current Protection		≥ 110%Io, hiccup, self-recovery				
Over-voltage Protection	24V output	≤ 35VDC				
	28V output	≤ 40VDC				
	35V output	≤ 45VDC				
Min. Load		0	--	--	%	
Trim	The total output power remains unchanged	--	--	±10		

MORNSUN®

MORNSUN GUANGZHOU SCIENCE & TECHNOLOGY CO.,LTD.

2019.10.15-A/2

Page 1 of 4

MORNSUN Guangzhou Science & Technology Co., Ltd. reserves the copyright and right of final interpretation

Hold-up Time	Room temperature, Full load	330VAC input	--	40	--	ms
		660VAC input	--	80	--	
Start-up Delay Time	85-900VAC	--	2	3	s	

Note: * The "Tip and barrel method" is used for ripple and noise test, please refer to AC-DC Converter Application Notes for specific information.
 ** Delay Time is tested over the full input voltage and the full output load range (The cooling-time between input power-off and power-on again is greater than 15s).

General Specifications

Item	Operating Conditions	Min.	Typ.	Max.	Unit	
Isolation Test	Input - output	4000	--	--	VAC	
Insulation Resistance	500VDC	$\geq 50 \times 10^6$			Ω	
Operating Temperature		-25	--	+70	$^{\circ}\text{C}$	
Storage Temperature		-40	--	+85		
Storage Humidity		--	--	95	%RH	
Power Derating	-25 $^{\circ}\text{C}$ to -10 $^{\circ}\text{C}$	2.6	--	--	%/ $^{\circ}\text{C}$	
	+50 $^{\circ}\text{C}$ to +70 $^{\circ}\text{C}$	28V/35V output	2.0	--		
	+50 $^{\circ}\text{C}$ to +60 $^{\circ}\text{C}$	24V output	1.4	--		
	+60 $^{\circ}\text{C}$ to +70 $^{\circ}\text{C}$	24V output	3.0	--	--	
	85VAC - 100VAC		2.0	--	--	%/ VAC
	850 VAC - 900VAC	24V output	0.4	--	--	
	28V/35V output	0.3	--	--		
Switching Frequency		--	65	--	kHz	
Altitude		--	--	5000	m	
MTBF		MIL-HDBK-217F@25 $^{\circ}\text{C}$ \geq 300,000 h				

Mechanical Specifications

Dimensions	155.00mm x 95.00mm x 41.00mm
Weight	340g (Typ.)
Cooling method	Free air convection

Electromagnetic Compatibility (EMC)

Immunity	Test Method	Standard	Level	Criteria
Immunity	ESD	IEC/EN61000-4-2	Contact $\pm 6\text{KV}$	perf. Criteria B
	RS	IEC/EN61000-4-3	10V/m	perf. Criteria A
	EFT	IEC/EN61000-4-4	$\pm 4\text{kV}$	perf. Criteria B
	Surge	IEC/EN61000-4-5	line to line $\pm 2\text{KV}$ /line to ground $\pm 4\text{KV}$	perf. Criteria B
	CS	IEC/EN61000-4-6	10Vr.m.s	perf. Criteria A

Product Characteristic Curve

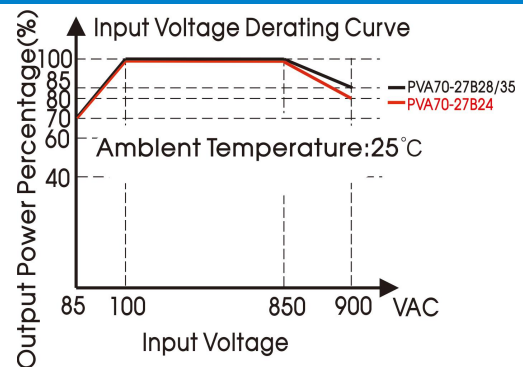
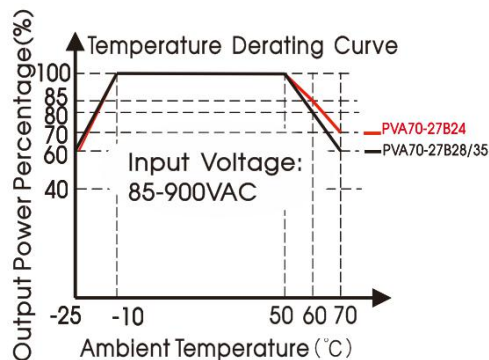

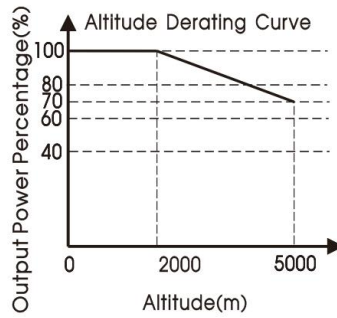

Note: ① With an input between 85 - 100VAC/850 -900VAC, the output power must be derated as per temperature derating curves;
 ② For operation of this converter series in an altitude between 2000 - 5000m, the output power must be derated as per the altitude derating curve;
 ③ This product is suitable for applications using natural air cooling; for applications in closed environment please consult factory or one of our FAE.

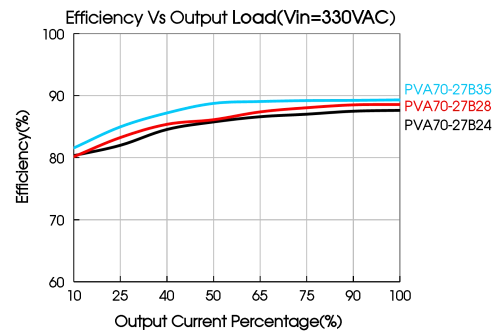
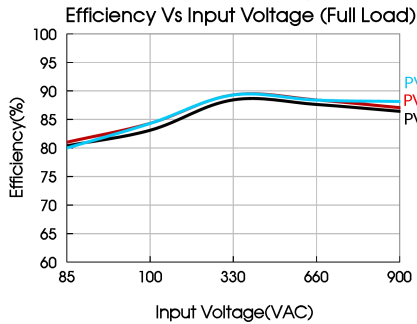

Design Reference

1. Typical application

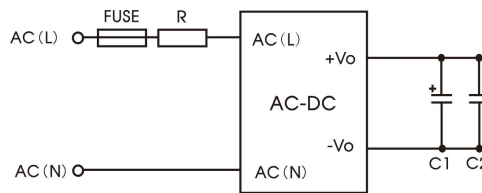

Fig. 1

Model	FUSE	C1	C2	R
PVA70-27Bxx	3.5A/1000VAC, required	10uF	1uF	1Ω / ≥5W

Output Filter Components:

We recommend using an electrolytic capacitor with high frequency, and low ESR rating for C1 (refer to manufacture's datasheet). Choose a capacitor voltage rating with at least 20% margin, in other words not exceeding 80%. C2 is a ceramic capacitor used for filtering high-frequency noise.

2. Trim Function for Output Voltage Adjustment (open if unused)

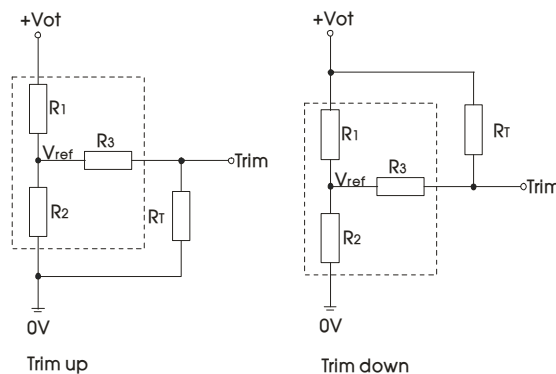

TRIM resistor connection (dashed line shows internal resistor network)

Calculating Trim resistor values:

$$\begin{aligned} \text{up: } R_T &= \frac{\alpha R_2}{R_2 - \alpha} \cdot R_3 & \alpha &= \frac{V_{ref}}{V_{ot} - V_{ref}} \cdot R_1 \\ \text{down: } R_T &= \frac{\alpha R_1}{R_1 - \alpha} \cdot R_3 & \alpha &= \frac{V_{ot} - V_{ref}}{V_{ref}} \cdot R_2 \end{aligned}$$

RT = Trim Resistor value;
α = Self-defined parameter;

V _{out}	R ₁ (KΩ)	R ₂ (KΩ)	R ₃ (KΩ)	V _{ref} (V)	V _{ot} (V)
24V	12.4	1.43	1	2.5	Resulting trimmed output voltage, range ≤ ±10%
28V	12.4	1.2	1	2.5	
35V	12.4	0.94	1	2.5	

3. For more information Please find the application notes on www.mornsun-power.com.

Dimensions and Recommended Layout

THIRD ANGLE PROJECTION 

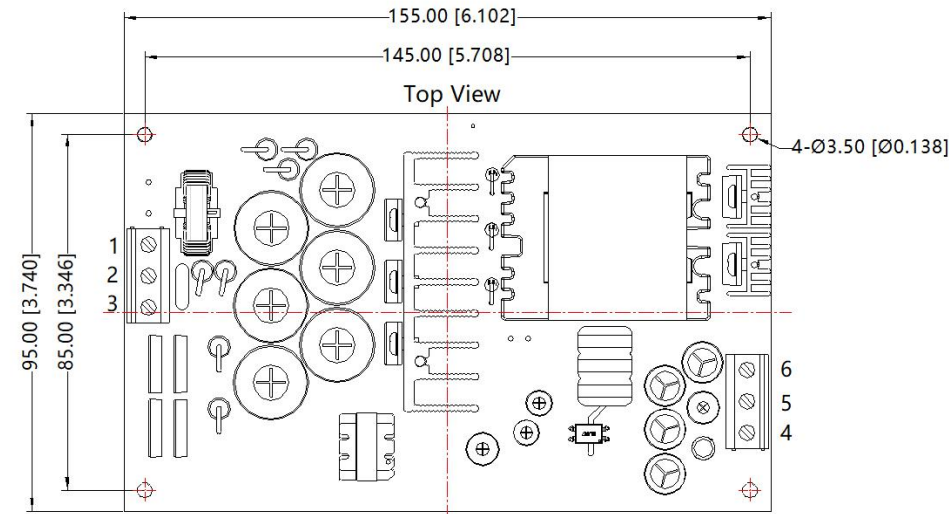

Pin-Out	
Pin	Function
1	AC(L)
2	NC
3	AC(N)
4	Trim
5	-V _o
6	+V _o

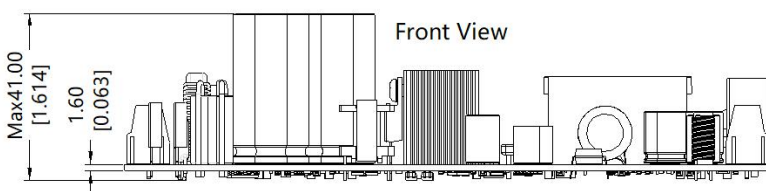

Note:
Unit: mm[inch]
Wire range: 24-12AWG
Tightening torque: Max 0.4 N·m
General tolerances: ±1.00[±0.039]
The layout of the device is for reference only, please refer to the actual product

Note:

- For additional information on Product Packaging please refer to www.mornsun-power.com. Packaging bag number: 58220071;
- Unless otherwise specified, parameters in this datasheet were measured under the conditions of T_a=25°C, humidity<75% with nominal input voltage and rated output load;
- All index testing methods in this datasheet are based on our company corporate standards;
- We can provide product customization service, please contact our technicians directly for specific information;
- Products are related to laws and regulations: see "Features" and "EMC";
- Our products shall be classified according to ISO14001 and related environmental laws and regulations, and shall be handled by qualified units.

Mornsun Guangzhou Science & Technology Co., Ltd.

Address: No. 5, Kehui St. 1, Kehui Development Center, Science Ave., Guangzhou Science City, Huangpu District, Guangzhou, P. R. China
Tel: 86-20-38601850 Fax: 86-20-38601272 E-mail: info@mornsun.cn www.mornsun-power.com