

DC/DC Converter

PV15-27BxxR3 Series

MORNSUN®

15W isolated DC-DC converter with ultra-wide, ultra-high 100-1000V DC input for Renewable Energy



FEATURES

- Input voltage up to 1200VDC (Transient, duration: 60s)
- Wide 10:1 input voltage range of 100 -1000VDC
- Industrial grade operating temperature -40°C to +70°C
- High I/O isolation test voltage of 4000VAC
- High efficiency, low ripple & noise
- Input reverse polarity protection, output short circuit, over-current, over-voltage protection
- High reliability, long service life
- Mounting options available for PCB mounting, chassis mounting and DIN-Rail mounting
- Reinforced insulation
- Customization is available

PV15-27BxxR3 series are regulated DC-DC converters with an ultra-wide and ultra-high DC input of 100-1000VDC. The products feature high efficiency, high reliability, high insulation and a high level of safety protection. This type of power supply is widely used in renewable energy industries such as photovoltaic, power generation, energy storage, inverters and high-voltage DC conversions. The converters provide multiple protection features and guarantee stable and safe operating environments even under abnormal working conditions. For extremely harsh EMC environment, we recommend using the application circuit show in Design Reference of this datasheet.

Selection Guide

| Certification | Model* | Output Power | Nominal Output Voltage and Current (Vo/Io) | Efficiency at 200VDC (% Typ.) | Capacitive Load (µF) Max. |
|---------------|--------------|--------------|--|-------------------------------|---------------------------|
| EN | PV15-27B12R3 | 15W | 12V/1.25A | 81 | 2000 |
| | PV15-27B15R3 | | 15V/1.00A | 81 | 1200 |
| | PV15-27B24R3 | | 24V/0.625A | 83 | 470 |

Note: *Use suffix "A2C" for chassis mounting and suffix "A4C" for DIN-Rail mounting.

Input Specifications

| Item | Operating Conditions | Min. | Typ. | Max. | Unit |
|-----------------------------------|----------------------------|--------------------|------|------|------|
| Input Voltage Range | | 100 | -- | 1000 | VDC |
| | Transient (60s) | -- | -- | 1200 | |
| Input Current | 200VDC | -- | -- | 120 | mA |
| | 600VDC | -- | -- | 40 | |
| | 1000VDC | -- | -- | 22 | |
| Inrush Current | 200VDC | -- | 7 | -- | A |
| | 600VDC | -- | 20 | -- | |
| | 1000VDC | -- | 30 | -- | |
| Input Under-voltage Protection | Lockout activation range | 60 | -- | 85 | VDC |
| | Lockout deactivation range | 75 | -- | 95 | |
| Input Reverse Polarity Protection | | Available | | | |
| External Input Fuse | | 2A/1000V, required | | | |
| Hot Plug | | Unavailable | | | |

MORNSUN®

MORNSUN Guangzhou Science & Technology Co., Ltd.

2021.09.05-A/4

Page 1 of 6

MORNSUN Guangzhou Science & Technology Co., Ltd. reserves the copyright and right of final interpretation

Output Specifications

| Item | Operating Conditions | | Min. | Typ. | Max. | Unit |
|-------------------------------|--------------------------------------|---------------|---------------------------|-------|-------|--------------------------------|
| Output Voltage Accuracy | | | -- | ±1 | ±2 | % |
| Line Regulation | | | -- | ±0.5 | ±1 | |
| Load Regulation | | | -- | ±0.5 | ±1 | |
| Ripple & Noise* | 20MHz bandwidth (peak-to-peak value) | | -- | 100 | 200 | mV |
| Temperature Drift Coefficient | | | -- | ±0.02 | ±0.15 | %/°C |
| Short Circuit Protection | | | Continuous, self-recovery | | | |
| Over-current Protection | | | ≥110%Io self-recovery | | | |
| Over-voltage Protection | PV15-27B12R3 | | ≤15VDC | | | Output voltage clamp or hiccup |
| | PV15-27B15R3 | | ≤19VDC | | | |
| | PV15-27B24R3 | | ≤28VDC | | | |
| Minimum Load | | | 0 | -- | -- | % |
| Start-up Delay Time | 100-1000VDC | | -- | -- | 1 | s |
| Hold-up Time | Room temperature, full load | 600VDC input | -- | 10 | -- | ms |
| | | 1000VDC input | -- | 30 | -- | |

Note: * The "parallel cable" method is used for ripple and noise test, please refer to PV Converter Application Notes for specific information.

General Specifications

| Item | Operating Conditions | | Min. | Typ. | Max. | Unit |
|-----------------------|----------------------|--|---|------|------|--------|
| Isolation | Input-output | Electric Strength Test for 1min., leakage current <5mA | 4000 | -- | -- | VAC |
| Insulation Resistance | Input-output | At 500VDC | 100 | -- | -- | MΩ |
| Operating Temperature | | | -40 | -- | +70 | °C |
| Storage Temperature | | | -40 | -- | +105 | |
| Storage Humidity | | | -- | -- | 95 | %RH |
| Soldering Temperature | Wave-soldering | | 260±5°C; time: 5-10s | | | |
| | Manual-welding | | 360±10°C; time: 3-5s | | | |
| Switching Frequency | | | -- | 65 | -- | kHz |
| Power Derating | -40°C to -30°C | 100-150VDC | 4 | -- | -- | % / °C |
| | +50°C to +70°C | | 2 | -- | -- | |
| | 100VDC- 200VDC | | 0.4 | -- | -- | %/VDC |
| | 2000m- 5000m | | 6.67 | -- | -- | %/km |
| Safety Standard | | | EN62109-1; Design refer to UL1741, CSA-C22.2 No.107.H6 | | | |
| MTBF | | | MIL-HDBK-217F@25°C > 300,000 h | | | |

Mechanical Specifications

| | | |
|----------------|--|-----------------------|
| Case Material | Black flame-retardant and heat-resistant plastic (UL94V-0) | |
| Dimensions | Horizontal package | 70.0 x 48.0 x 23.5 mm |
| | A2C chassis mounting | 96.1 x 54.0 x 32.0 mm |
| | A4C DIN-Rail mounting | 96.1 x 54.0 x 36.6 mm |
| Weight | Horizontal package | 115g (Typ.) |
| | A2C chassis mounting | 170g (Typ.) |
| | A4C DIN-Rail mounting | 210g (Typ.) |
| Cooling method | Free air convection | |

Electromagnetic Compatibility (EMC)

| | | | | |
|-----------|-----------------|-----------------|--|------------------|
| Emissions | CE | CISPR32/EN55032 | CLASS A (See Fig. 2 for recommended circuit) | |
| | RE | CISPR32/EN55032 | CLASS A | |
| Immunity | ESD | IEC/EN61000-4-2 | Contact $\pm 6\text{KV}$ /Air $\pm 8\text{KV}$ | Perf. Criteria B |
| | RS | IEC/EN61000-4-3 | 10V/m | perf. Criteria A |
| | EFT | IEC/EN61000-4-4 | $\pm 4\text{KV}$ | perf. Criteria B |
| | Surge | IEC/EN61000-4-5 | line to line $\pm 1\text{KV}$ | perf. Criteria B |
| | | | line to line $\pm 2\text{KV}$ (See Fig. 2 for recommended circuit) | perf. Criteria B |
| CS | IEC/EN61000-4-6 | 10Vr.m.s | perf. Criteria A | |

Product Characteristic Curve

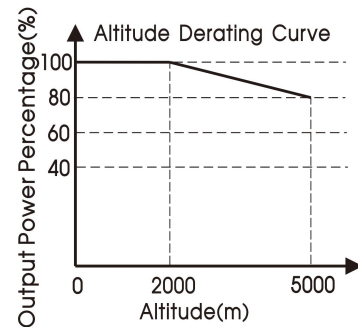
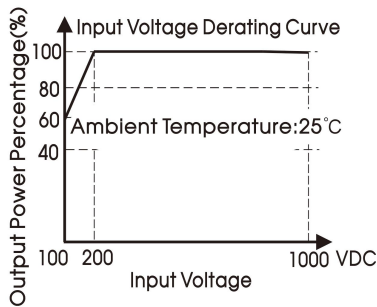
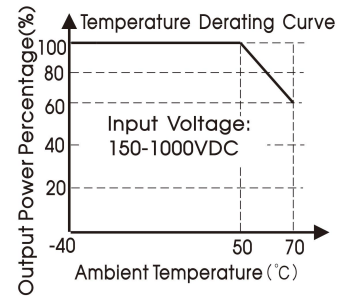
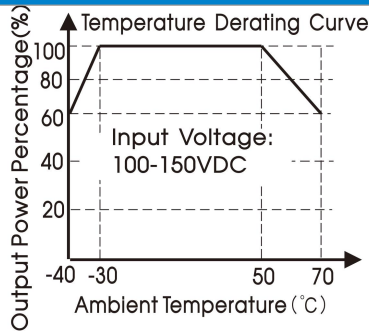

Note: ① With an input between 100 - 200VDC, the output power of PV15-27BxxR3 parts must be derated as per temperature derating curves;
② This product is suitable for use in natural air cooling environments, if in a closed environment, please contact our company's FAE.

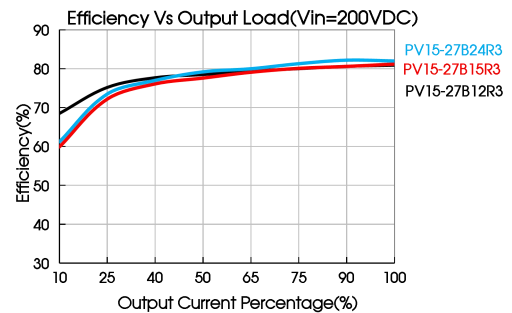
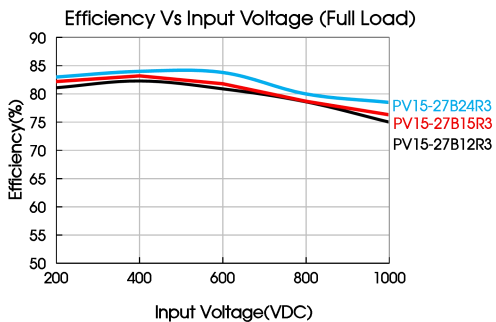

Design Reference

1. Typical application

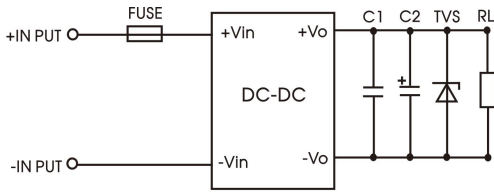

| Model | FUSE | C1(μF) | C2(μF) | TVS |
|--------------|-------------------------|--------|--------|---------|
| PV15-27B12R3 | 2A/1000VDC, required | 1 | 120 | SMBJ20A |
| PV15-27B15R3 | | | | SMBJ30A |
| PV15-27B24R3 | | | | SMBJ30A |

Fig. 1: Typical application circuit

Note on filter components:

We recommend using an electrolytic capacitor with high frequency and low ESR rating for C2 (refer to manufacture's datasheet). Choose a capacitor voltage rating with at least 20% margin, in other words not exceeding 80%. C1 is a ceramic capacitor, used to filter high-frequency noise. TVS is a recommended suppressor diode to protect the application in case of a converter failure.

2. EMC compliance recommended circuit

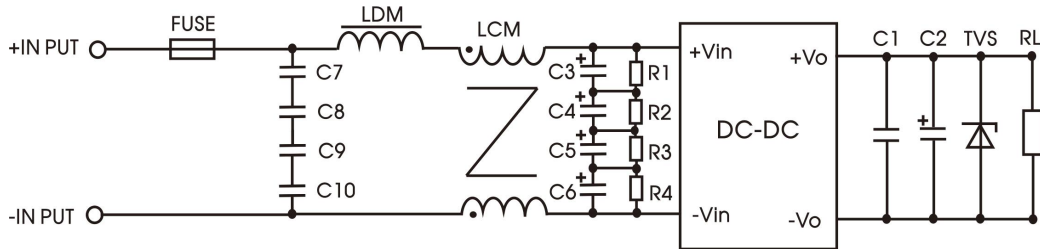
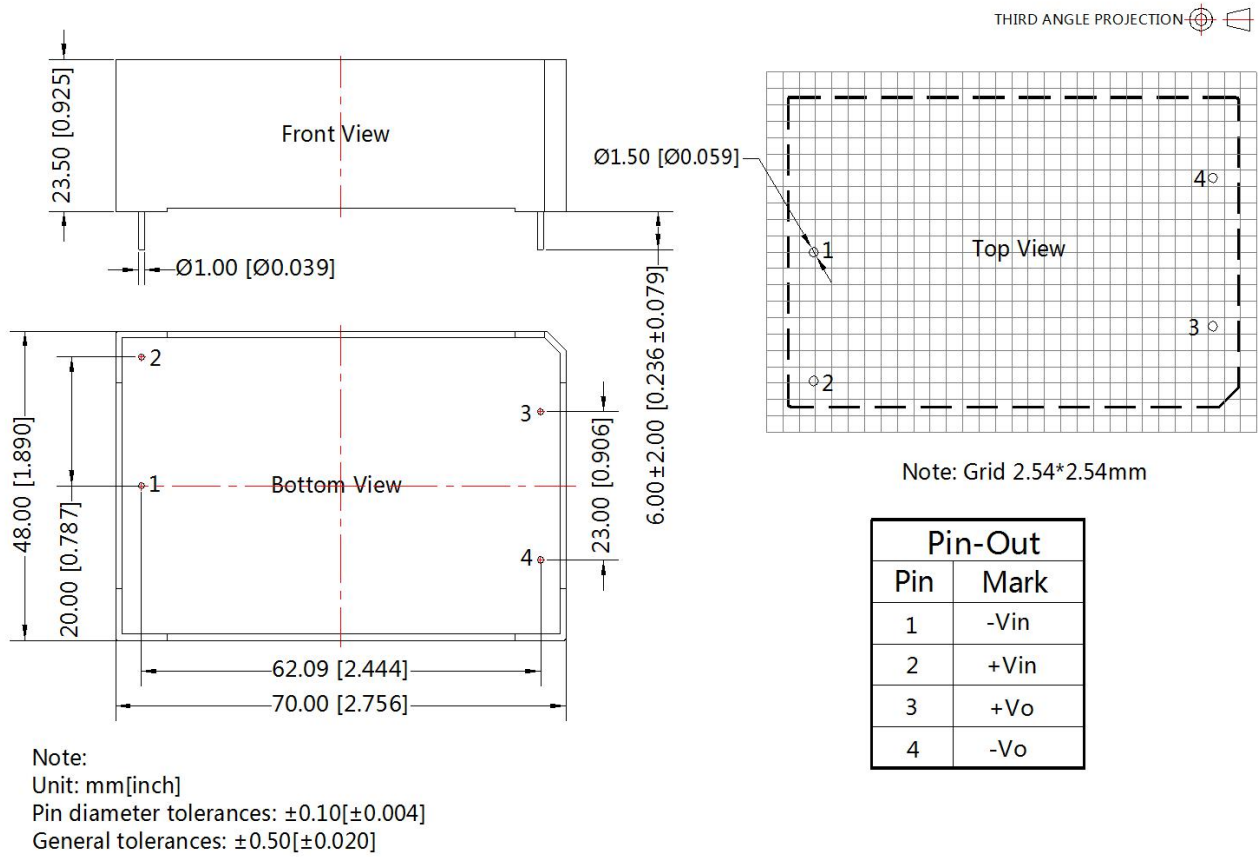

Fig 2: EMC application for higher compliance requirements (output parameters are show in Figure 1)

| Component | Recommended value |
|--------------|--------------------|
| C3/C4/C5/C6 | 10uF/400VDC |
| C7/C8/C9/C10 | 224K/275VAC |
| R1/R2/R3/R4 | 1MΩ/0.25W |
| LDM | 1.2mH/0.38A |
| LCM | 10mH |
| FUSE | 2A/1000V, required |

3. For additional information please refer to application notes on www.mornsun-power.com.

Dimensions and Recommended Layout



A2C Chassis Mounting Dimensions

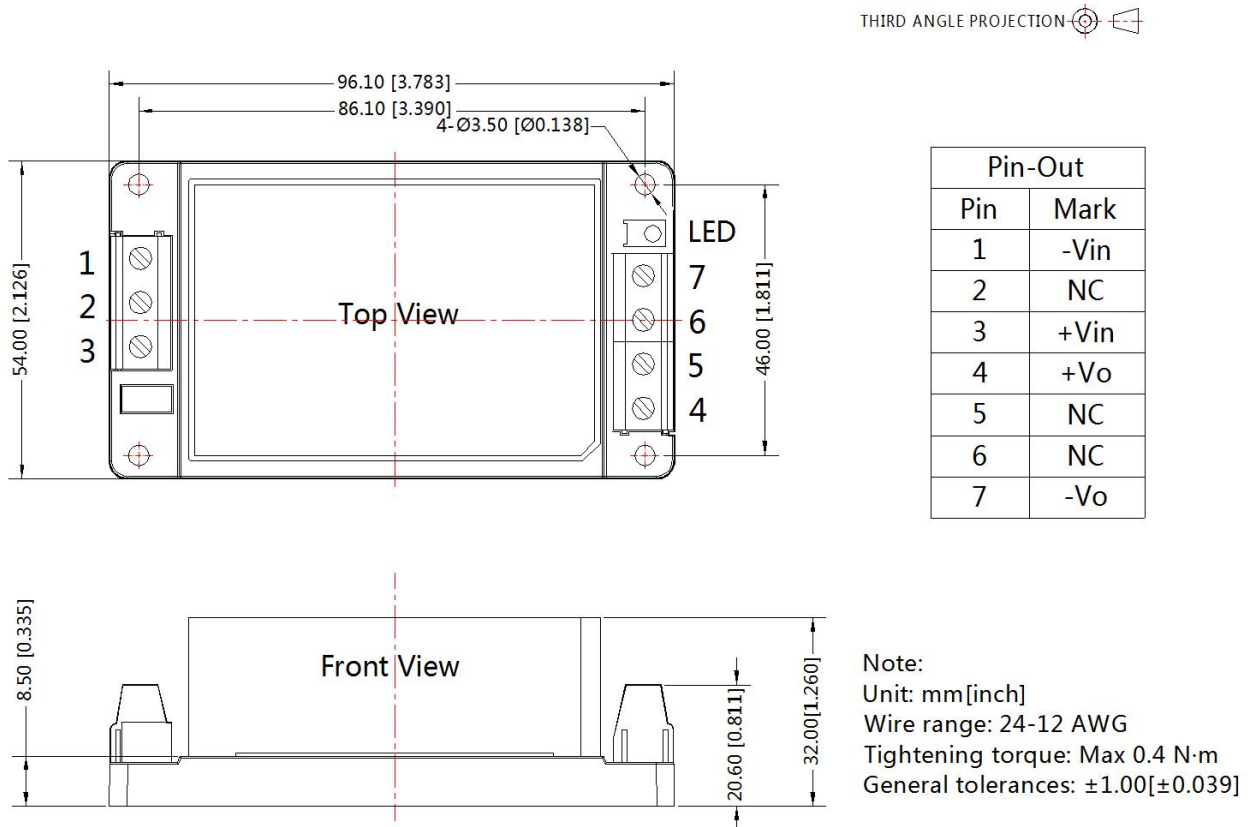

A4C Din-Rail mounting Dimensions

THIRD ANGLE PROJECTION 

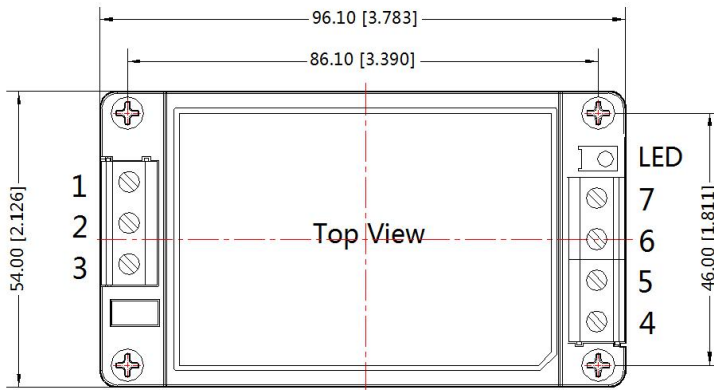

| Pin-Out | |
|---------|------|
| Pin | Mark |
| 1 | -Vin |
| 2 | NC |
| 3 | +Vin |
| 4 | +Vo |
| 5 | NC |
| 6 | NC |
| 7 | -Vo |

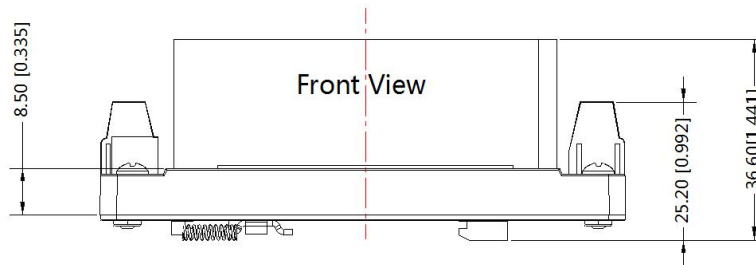

Note:

Unit: mm[inch]

Mounting rail: TS35, rail needs to

connect safety ground

Wire range: 24-12 AWG

Tightening torque: Max 0.4 N·m

General tolerances: $\pm 1.00[\pm 0.039]$

Note:

1. For additional information on Product Packaging please refer to www.mornsun-power.com. Packaging bag number: 58220006; the packaging bag number of A2C/A4C package: 58220192;
2. Unless otherwise specified, parameters in this datasheet were measured under the conditions of $T_a=25^\circ\text{C}$, humidity<75% with nominal input voltage and rated output load;
3. All index testing methods in this datasheet are based on our company corporate standards;
4. We can provide product customization service, please contact our technicians directly for specific information;
5. Specifications are subject to change without prior notice.

Mornsun Guangzhou Science & Technology Co., Ltd.

Address: No. 5, Kehui St. 1, Kehui Development Center, Science Ave., Guangzhou Science City, Huangpu District, Guangzhou, P. R. China
Tel: 86-20-38601850 Fax: 86-20-38601272 E-mail: info@mornsun.cn www.mornsun-power.com