

75W, specific power supply for power grid

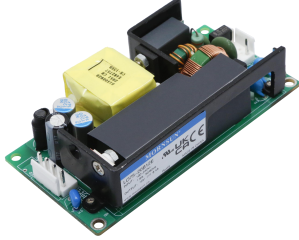

FEATURES

- Specific power supply designing for smart grid
- Universal 85-264VAC or 88-370VDC input voltage
- Ultra-wide operating ambient temperature range: -40°C to +85°C
- High reliability, low output ripple & noise
- Immunity meets electricity standard Level 4
- Meets impulse voltage requirements of 1.2/50us 5KV

LO75-20BxxE series is a special power supply design for the smart grid industry that meets the power industry standards. It features AC input and at the same time accepts DC input voltage, wide operating temperature range, high EMS level, high reliability, and high isolation. EMC and safety specifications meet IEC/EN61000-4, CISPR32/EN55032, UL/EN/IEC62368 standards. It is suitable for smart grid occasions with poor power quality and high reliability requirements, such as smart power transmission and substations. It also can be used in microcomputer protection equipment, bus voltage protection equipment or equipment with high reliability requirements that require 110VDC input voltage.

Selection Guide

Certification	Part No.	Output Power	Nominal Output Voltage and Current (Vo/Io)	Output Voltage Adjustable Range ADJ (V)*	Efficiency at 230VAC (%) Typ.	Capacitive Load (μF) Max.
EN/IEC/UKCA	LO75-20B03E	39.6W	3.3V/12A	--	82	8500
	LO75-20B05E	60W	5V/12A	4.5-5.5	84	8500
	LO75-20B09E	75.6W	9V/8.4A	8.1-9.9	86	7500
UL/EN/IEC/UKCA	LO75-20B12E	76.8W	12V/6.4A	10.8-13.2	88	6800
	LO75-20B15E	75W	15V/5A	13.5-16.5	88	4700
EN/IEC/UKCA	LO75-20B24E	76.8W	24V/3.2A	21.6-26.4	89	2200
	LO75-20B27E	75.6W	27V/2.8A	24.3-29.7	89	1200
	LO75-20B48E	76.8W	48V/1.6A	43.2-52.8	90	680

Note: *The actual adjustment range may extend outside the values stated, care should be exercised to ensure that the output voltage and power levels remain within the published maximum values.

Input Specifications

Item	Operating Conditions	Min.	Typ.	Max.	Unit
Input Voltage Range	AC input	85	--	264	VAC
	DC input	88	--	370	VDC
Input Frequency		47	--	63	Hz
Input Current	115VAC	--	--	1.6	A
	230VAC	--	--	0.9	
Inrush Current	115VAC	--	25	--	
	230VAC	--	45	--	
Leakage Current	240VAC	0.5mA RMS max.			
Hot Plug		Unavailable			

Output Specifications

Item	Operating Conditions	Min.	Typ.	Max.	Unit	
Output Voltage Accuracy	0% - 100% load	3.3V output	--	±3	--	%
		Other output	--	±2	--	
Line Regulation	Rated load	3.3V output	--	±0.8	--	
		Other output	--	±0.5	--	
Load Regulation	0% - 100% load	--	±1	--		
Ripple & Noise*	20MHz bandwidth (peak-to-peak value)	--	--	200	mV	
Stand-by Power Consumption		--	0.5	--	W	
Short Circuit Protection		Hiccup, continuous, self-recovery				

Over-voltage Protection	3.3VDC output	≤5.25V	Output voltage clamp or hiccup		
	5VDC output	≤7.25V			
	9VDC output	≤13V			
	12VDC output	≤16V			
	15VDC output	≤21V			
	24VDC output	≤35V			
	27VDC output	≤39V			
	48VDC output	≤60V			
Over-current Protection		≥110%Io, self-recovery			
Minimum Load		0	--	--	%
Start-up Delay Time	85VAC-264VAC input, Io=100%	--	--	500	ms
Hold-up Time	115VAC input, Io=100%	--	12	--	ms
	230VAC input, Io=100%	--	90	--	
Note: *The "Tip and barrel method" is used for ripple and noise test, with a 0.1uf ceramic capacitor & 100uf parallel capacitor, please refer to AC-DC Converter Application Notes for specific information.					

General Specifications

Item		Operating Conditions	Min.	Typ.	Max.	Unit
Isolation	Input - output	Electric Strength Test for 1min., leakage current <8mA	4000	--	--	VAC
	Input - PE	Electric Strength Test for 1min., leakage current <5mA	2000	--	--	
	Output - PE	Electric Strength Test for 1min., leakage current <10mA	500	--	--	
Insulation Resistance	Input - output	500VDC	50	--	--	MΩ
	Input - PE					
	Output - PE					
Impulse Withstand Voltage	Input - output	5KV, 1.2/50 us Impulse voltage				
	Input - PE					
Operating Temperature			-40	--	+85	°C
Storage Temperature			-40	--	+105	
Storage Humidity			--	--	90	%RH
Altitude			--	--	5000	m
Switching Frequency			--	65	--	kHz
Power Derating	-40°C to -25°C		2	--	--	% / °C
	+50°C to +60°C		1	--	--	
	+60°C to +70°C	3.3V/5V	1.5	--	--	
		9V/12V/15V/24V /27V/48V	2.5	--	--	
	+70°C to +85°C	3.3V/5V	2.33	--	--	
		9V/12V/15V/24V /27V/48V	1.67	--	--	
	85VAC - 100VAC		1.33	--	--	
2000m-5000m		5	--	--	%/Km	
Safety Standard	LO75-20B03/05/09/24/27/48E		IEC62368-1 safety approved & EN62368-1, BS EN 62368-1 (Report); Design refer to UL62368-1			
	LO75-20B12/15E		UL/IEC62368-1 safety approved & EN62368-1, BS EN 62368-1 (Report)			
Safety Class			CLASS I			
MTBF			MIL-HDBK-217F@25°C > 300,000 h			
Designed life	230VAC	+25°C	≥ 130 x 10 ³ h			
		+50°C	≥ 70 x 10 ³ h			
		+70°C	≥ 44 x 10 ³ h			
		+85°C	> 29 x 10 ³ h			

Mechanical Specifications

Dimension	101.60 x 50.80 x 27.00mm
Weight	140g (Typ.)
Cooling method	Convection air cooling

Electromagnetic Compatibility (EMC)

Emissions	CE	CISPR32/EN55032	CLASS B	
	RE	CISPR32/EN55032	CLASS A	
	Harmonic current	IEC/EN61000-3-2	CLASS A	
	Voltage flicker	IEC/EN61000-3-3	CLASS A	
Immunity	ESD	IEC/EN61000-4-2	Contact $\pm 8KV$ /Air $\pm 15KV$	Perf. Criteria B
	RS	IEC/EN61000-4-3	10V/m	Perf. Criteria A
	EFT	IEC/EN61000-4-4	$\pm 4KV$	Perf. Criteria B
	Surge	IEC/EN61000-4-5	Line to line $\pm 2KV$ / line to ground $\pm 4KV$	Perf. Criteria B
	CS	IEC/EN61000-4-6	10Vr.m.s	Perf. Criteria A
	Voltage dips, short interruption and voltage variations	IEC/EN61000-4-11	100% dip 1 periods, 30% dip 25 periods, 100% interruptions 250 periods	Perf. Criteria B
	Walkie-talkie interference test	MS-SOP-DQC-007		Perf. Criteria B

Product Characteristic Curve

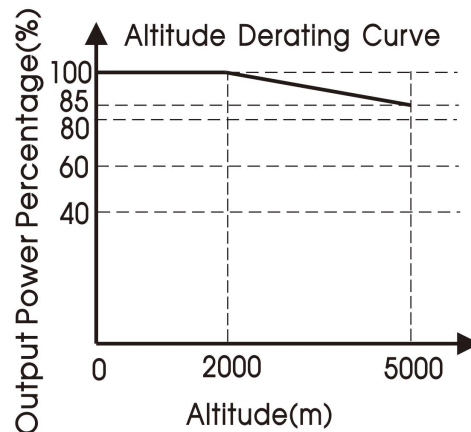
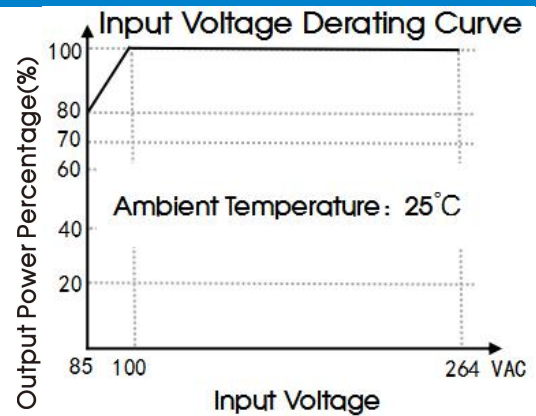
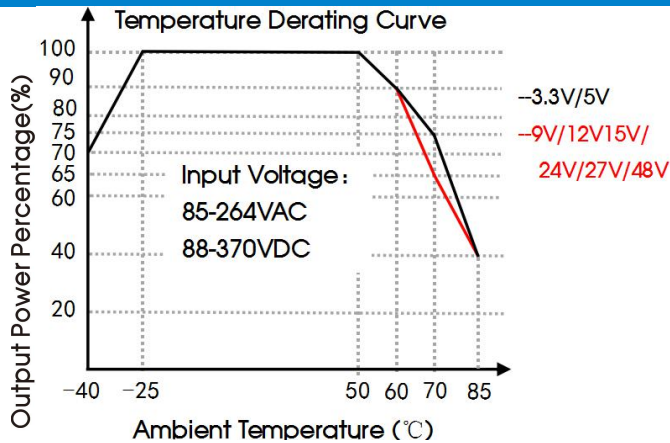

Note: ① With an AC input between 85-100VAC, the output power must be derated as per temperature derating curves;
② This product is suitable for applications using convection air cooling; for applications in closed environment please consult Mornsun FAE.

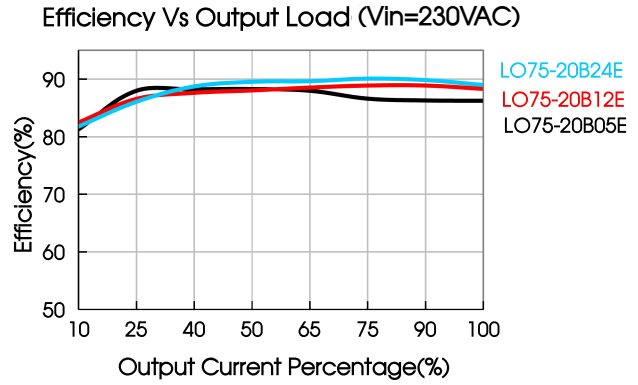
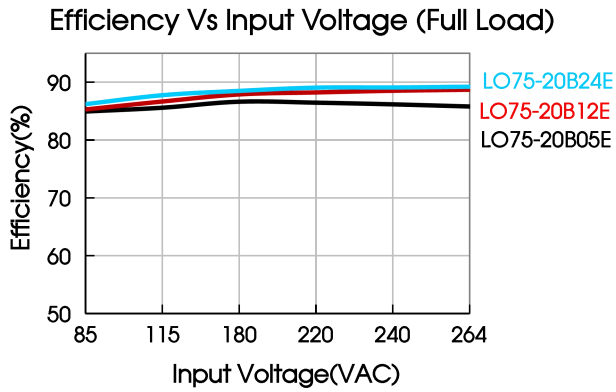

Design Reference

1. Typical application

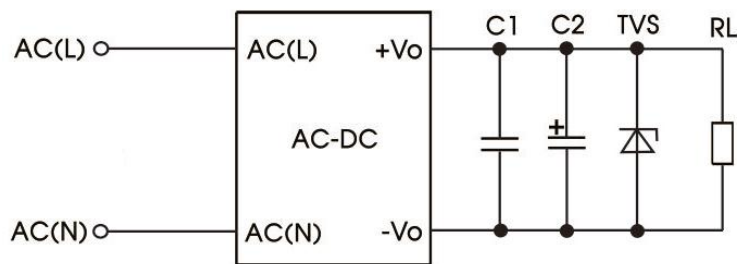

Fig. 1: Typical circuit diagram

Part no.	C1	C2	TVS
LO75-20B03E	0.1μF/250V	100μF/63V	SMBJ7.0A
LO75-20B05E			SMBJ7.0A
LO75-20B09E			SMBJ12A
LO75-20B12E			SMBJ20A
LO75-20B15E			SMBJ20A
LO75-20B24E			SMBJ30A
LO75-20B27E			SMBJ30A
LO75-20B48E			SMBJ64A

Output Filter Components:

We recommend using an electrolytic capacitor with high frequency, and low ESR rating for C2 (refer to manufacture's datasheet). Choose a capacitor voltage rating with at least 20% margin, in other words not exceeding 80%. C1 is a ceramic capacitor used for filtering high-frequency noise and TVS is a recommended suppressor diode to protect the application in case of a converter failure.

2. For additional information please refer to application notes on www.mornsun-power.com.

Dimensions and Recommended Layout

THIRD ANGLE PROJECTION 

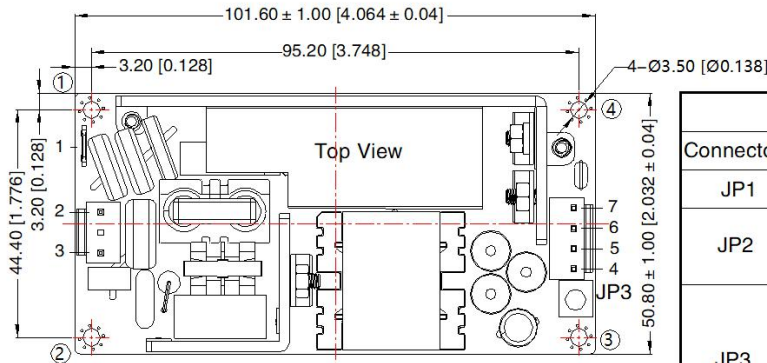

Pin-Out			
Connectors	Pin	Mark	Client Connectors
JP1	1	PE	KST FDD 5.5-250 or equivalent
JP2	2	AC(N)	Housing: JST VHR Contact: JSTSVH-21T-P1.1 or equivalent
	3	AC(L)	
JP3	4	-Vo	Housing: JST VHR Contact: JSTSVH-21T-P1.1 or equivalent
	5	-Vo	
	6	+Vo	
	7	+Vo	

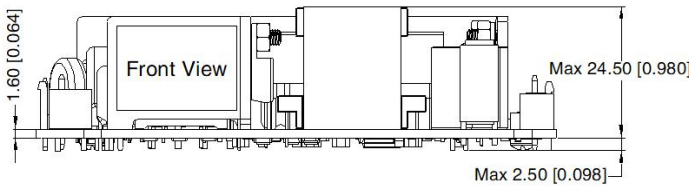

Position	Screw Spec.	L(Recommend)	Torque(max)
① - ④	M3	6mm	0.4N · m

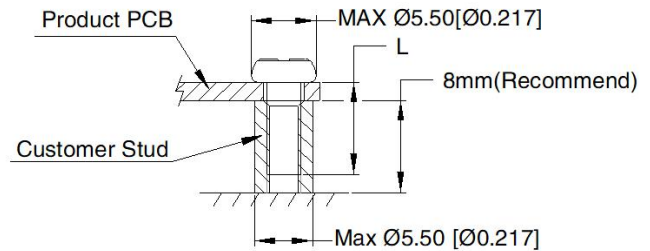

Note:
Unit: mm[inch]
General tolerances: $\pm 0.50[\pm 0.020]$
The layout of the device is for reference only,
please refer to the actual product

- Note:
- For additional information on Product Packaging please refer to www.mornsun-power.com. Packaging bag number: 58220192
 - Unless otherwise specified, parameters in this datasheet were measured under the conditions of $T_a=25^\circ\text{C}$, humidity<75% with nominal input voltage and rated output load;
 - All index testing methods in this datasheet are based on our company corporate standards;
 - We can provide product customization service, please contact our technicians directly for specific information;
 - Products are related to laws and regulations: see "Features" and "EMC";
 - Our products shall be classified according to ISO14001 and related environmental laws and regulations, and shall be handled by qualified units.

Mornsun Guangzhou Science & Technology Co., Ltd.

Address: No. 5, Kehui St. 1, Kehui Development Center, Science Ave., Guangzhou Science City, Huangpu District, Guangzhou, P. R. China
Tel: 86-20-38601850 Fax: 86-20-38601272 E-mail: info@mornsun.cn www.mornsun-power.com