

FEATURES

- Universal 85 - 264VAC or 120 ~ 373VDC Input voltage
- Accepts AC or DC input (dual-use of same terminal)
- Operating ambient temperature range: -30°C ~ +70°C
- Low standby power consumption, high efficiency
- High I/O isolation test voltage up to 4000VAC
- Low ripple & noise
- Output short circuit, over-current, over-voltage protection
- Safety according to IEC/EN/UL62368, EN60335, GB4943 (CE/CCC pending)
- Withstand 300VAC surge input for 5s
- Over-voltage class III (designed to meet EN61558)
- Operating up to 5000m altitude

LM100-20Bxx series is one of Mornsun's enclosed AC-DC switching power supply. It features universal AC input and at the same time accepts DC input voltage, cost-effective, low no load power consumption, high efficiency and high reliability. These converters offer excellent EMC performance and meet IEC/EN61000-4, CISPR32/EN55032/IEC/UL/EN62368, EN60335, GB4943 standards and they are widely used in areas of industrial, LED, street light control, electricity, security, telecommunications, smart home etc.

Selection Guide

Certification	Part No.	Output Power(W)	Nominal Output Voltage and Current (Vo/Io)	Output Voltage Adjustable Range(V)	Efficiency at 230VAC (%) Typ.	Max. Capacitive Load (μF)
CE/CCC (Pending)	LM100-20B05	90	5V/18A	4.5-5.5	86	10000
	LM100-20B12	102	12V/8.5A	10.2-13.8	87.5	6800
	LM100-20B15	105	15V/7.0A	13.5-18	87.5	3300
	LM100-20B24	108	24V/4.5A	21.6-28.8	90	2200
	LM100-20B36	100.8	36V/2.8A	32.4-39.6	90	1000
	LM100-20B48	110.4	48V/2.3A	43.2-52.8	91	470

Input Specifications





Item	Operating Conditions		Min.	Typ.	Max.	Unit
Input Voltage Range	AC input		85	--	264	VAC
	DC input		120	--	373	VDC
Input Voltage Frequency			47	--	63	Hz
Input Current	115VAC		--	--	3	A
	230VAC		--	--	1.5	
Inrush Current	115VAC		--	35	--	
	230VAC		--	65	--	
Hot Plug			Unavailable			

Output Specifications

Item	Operating Conditions		Min.	Typ.	Max.	Unit
Output Voltage Accuracy	Full load range		5V	±2	--	%
			12V/15V/24V/36V/48V	±1	--	
Line Regulation	Rated load		--	±0.5	--	
Load Regulation	0% - 100% load		5V	±1	--	
			12V/15V/24V/36V/48V	±0.5	--	

Output Ripple & Noise*	20MHz bandwidth (peak-to-peak value)	5V	--	100	--	mV
		12V/15V	--	120	--	
		24V	--	150	--	
		36V/48V	--	200	--	
Temperature Coefficient			--	±0.03	--	%/°C
Minimum Load			0	--	--	%
Stand-by Power Consumption	230VAC	5V/12V/15V/24V	--	--	0.3	W
		36V/48V	--	--	0.5	
Hold-up Time	115VAC		5	10	--	ms
	230VAC		45	55	--	
Short Circuit Protection	Recovery time <5s after the short circuit disappear.		Hiccup, continuous, self-recovery			
Over-current Protection			110%-160% Io, self-recovery			
Over-voltage Protection	5V	≤ 7.5VDC (Output voltage turn off re-power on for recovery)				
	12V	≤ 19.2VDC (Output voltage clamp)				
	15V	≤ 24VDC (Output voltage clamp)				
	24V	≤ 38.4VDC (Output voltage clamp)				
	36V	≤ 57.6VDC (Output voltage clamp)				
	48V	≤ 60VDC (Output voltage turn off re-power on for recovery)				
Note: *The "Tip and barrel method" is used for ripple and noise test, please refer to AC-DC Converter Application Notes for specific information.						

General Specifications

Item	Operating Conditions		Min.	Typ.	Max.	Unit	
Isolation Test	Input - 	Electric strength test for 1min., leakage current <10mA	2000	--	--	VAC	
	Input-Output		4000	--	--		
	Output - 		1250	--	--		
Insulation Resistance	Input - 	At 500VDC	100	--	--	MΩ	
	Input - Output		100	--	--		
	Output - 		100	--	--		
Operating Temperature			-30	--	+70	°C	
Storage Temperature			-40	--	+85	°C	
Storage Humidity	Non-condensing		10	--	95	%RH	
Switching Frequency			--	65	--	kHz	
Power Derating	Operating temperature derating	5V output	+45°C~+70°C	1.6	--	--	% / °C
		Other output	+50°C~+70°C	2.0	--	--	
	Input voltage derating	85VAC-115VAC	0.67	--	--	%/VAC	
Safety Standard			Meet IEC/EN/UL62368, EN60335, GB4943				
Safety Class			CLASS I				
MTBF	MIL-HDBK-217F@25°C		>30,000 h				

Mechanical Specifications

Case Material	Metal (AL1100, SGCC)	
Dimensions	129.00 x 97.00 x 30.00mm	
Weight	350g (Typ.)	5V
	330g (Typ.)	12V/15V/24V/36V/48V
Cooling Method	Free air convection	

Electromagnetic Compatibility (EMC)

Emissions	CE	CISPR32/EN55032 CLASS B		
	RE	CISPR32/EN55032 CLASS B		
	Harmonic current	IEC/EN61000-3-2 CLASS A		
Immunity	ESD	IEC/EN 61000-4-2	Contact ±6KV /Air ±8KV	Perf. Criteria A
	RS	IEC/EN 61000-4-3	10V/m	perf. Criteria A
	EFT	IEC/EN 61000-4-4	±2KV	perf. Criteria A
	Surge	IEC/EN 61000-4-5	line to line ±2KV/line to ground ±4KV	perf. Criteria A
	CS	IEC/EN61000-4-6	10 Vr.m.s	perf. Criteria A
	Voltage dips, short interruptions and voltage variations	IEC/EN61000-4-11	0%, 70%	perf. Criteria B

Product Characteristic Curve

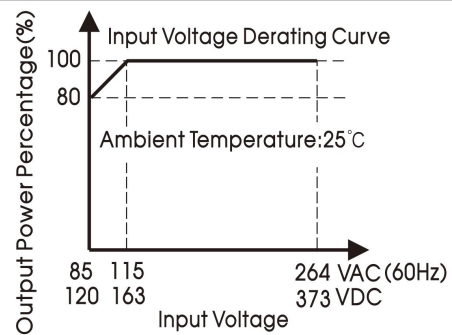
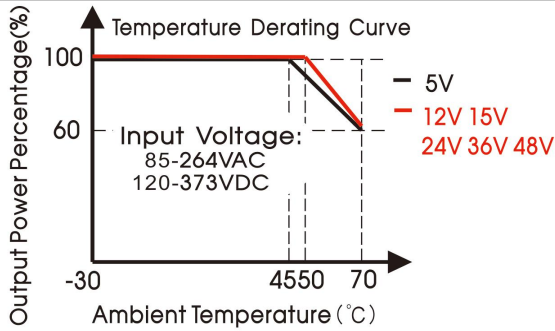

Note: ①With an input voltage between 85-115VAC and a DC input between 120-163VDC the output power must be derated as per the temperature derating curves;
②This product is suitable for applications using natural air cooling; for applications in closed environment please consult Mornsun FAE.

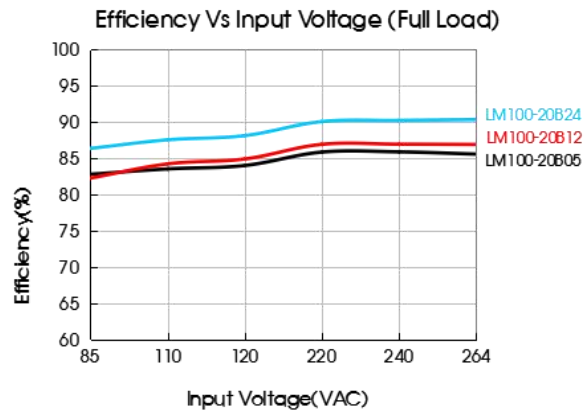
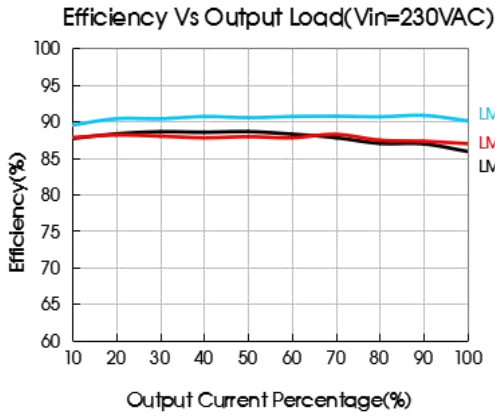

Dimensions and Recommended Layout

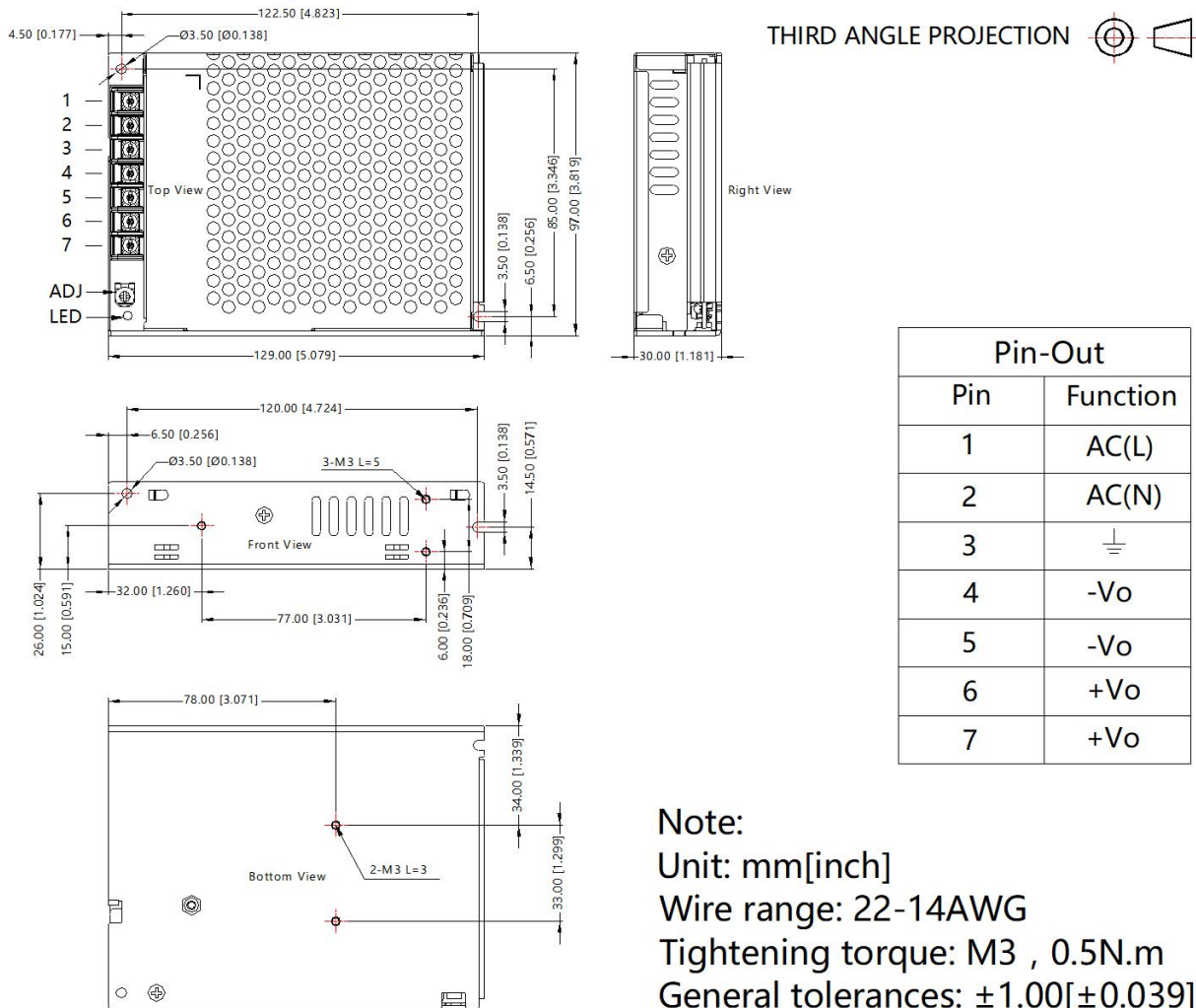

Note:

- For additional information on Product Packaging please refer to www.mornsun-power.com. Packaging bag number: 58220065;
- Unless otherwise specified, parameters in this datasheet were measured under the conditions of Ta=25°C, humidity<75%RH with nominal input voltage and rated output load;
- The ambient temperature derating of 5°C/1000m is needed for operating altitude greater than 2000m;
- All index testing methods in this datasheet are based on our company corporate standards;
- In order to improve the efficiency at high input voltage, there will be audible noise generated, but it does not affect product performance and reliability;
- We can provide product customization service, please contact our technicians directly for specific information;
- Products are related to laws and regulations: see "Features" and "EMC";
- Our products shall be classified according to ISO14001 and related environmental laws and regulations, and shall be handled by qualified units.
- The power supply is considered a component which will be installed into a final equipment. All EMC tests should be confirmed with the final equipment. Please consult our FAE for EMC test operation instructions.

Mornsun Guangzhou Science & Technology Co., Ltd.

Address: No. 5, Kehui St. 1, Kehui Development Center, Science Ave., Guangzhou Science City, Luogang District, Guangzhou, P. R. China

Tel: 86-20-38601850

Fax: 86-20-38601272

E-mail: info@mornsun.cn

www.mornsun-power.com



MORNSUN GUANGZHOU SCIENCE & TECHNOLOGY CO.,LTD.