

EMC Filter

FEATURES

- Compact size, high isolation
- High efficiency up to 97%
- EMC filters provide compliance with requirements of IEC/EN61000-4 and CISPR32/ EN55032 when used in combination with power converter modules
- Cost-effective

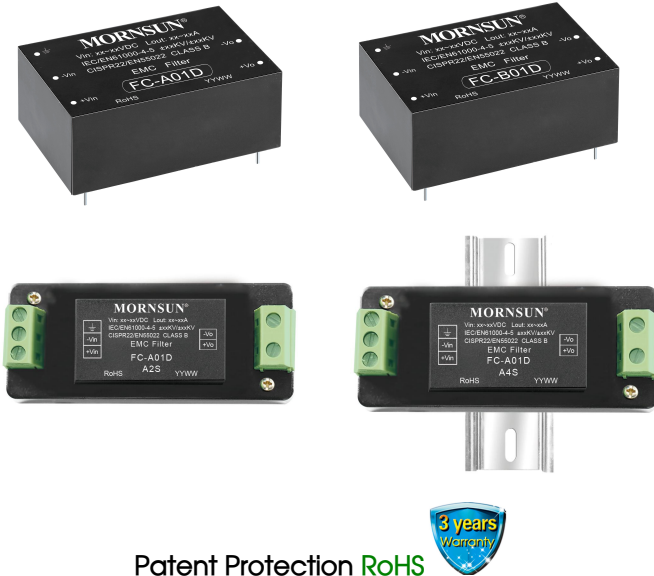

Patent Protection RoHS



These filter modules are extremely useful in noise-sensitive analog circuit applications. For compliance with IEC/EN61000-4-5 with surge levels of $\pm 2kV$ (2Ω source resistance)/ $\pm 4kV$ (12Ω source resistance) use FC-A01D & FC-B01D on the input side of DC/DC converter module to ensure the module is protected from surges. In addition it ensures that the EMI noise levels meet the requirement of CISPR32 /EN55032 Class B.

With EMC filter used to protect MORNSUN DC-DC converter modules, the system's max. input voltage and input current must not exceed the EMC filter's maximum Voltage and/or nominal current specifications.

Selection Guide

Model	Input Voltage Range (VAC)	Nominal Current (A)(max)
FC-A01D	9-36	1
FC-B01D	18-75	1

Note: Add suffix "A2S" for chassis mounting (example FC-A01DA2S), and suffix "A4S" for DIN-Rail mounting (example FC-A01DA4S).

General Specifications

Item	Test Conditions	Min.	Typ.	Max.	Unit
Efficiency	24VDC @1A	--	97	--	%
Operating Temperature		-40	--	85	°C
Storage Temperature		-55	--	105	
Case Temperature Rise	24VDC @1A	--	15	--	
Test Voltage (L/PE, N/PE)	Tested for 1 minute and leakage current: 5 mA	--	1.5	--	KVAC

Mechanical Specifications

Case Material	Black epoxy resin; flame-retardant, heat-resistant (UL94 V-0)	
Dimensions	Horizontal package	37.00 x 23.00 x 15.00 mm
	A2S chassis mounting	76.00 x 31.50 x 23.80 mm
	A4S A4S DIN-Rail mounting	76.00 x 31.50 x 28.40 mm
Weight	Horizontal package/A2S chassis mounting/A4S DIN-Rail mounting	20.0g/40.0g/60.0g(Typ.)

SAFE & EMC

Item	Test Conditions	Test Procedure
Emissions	Conducted disturbance	150KHz-30MHz Class B (With MORNSUN's Module) CISPR32, EN55032
	Radiated emission	30MHz-1GHz Class B (With MORNSUN's Module) CISPR32, EN55032

Immunity	Electrostatic discharge	Air ±8KV Contact ±6KV	perf.Criteria B	IEC/EN61000-4-2, GB/T17626.2
	Radiation Immunity	10V/m (With MORNSUN's Module)	perf.Criteria A	IEC/EN61000-4-3, GB/T17626.3
	Conducted disturbance immunity	10Vr.m.s (With MORNSUN's Module)	perf.Criteria A	IEC/EN61000-4-6, GB/T17626.6
	EFT	±4KV (5KHz,100KHz)	perf. Criteria B	IEC/EN61000-4-4, GB/T17626.4
	Surge immunity	±2KV (1.2µs/50µs 2Ω) ±4KV (1.2µs/50µs 12Ω)	perf. Criteria B	IEC/EN61000-4-5, GB/T17626.5

Electromagnetic Compatibility (EMC)

① FC-A01D Surge Test Result

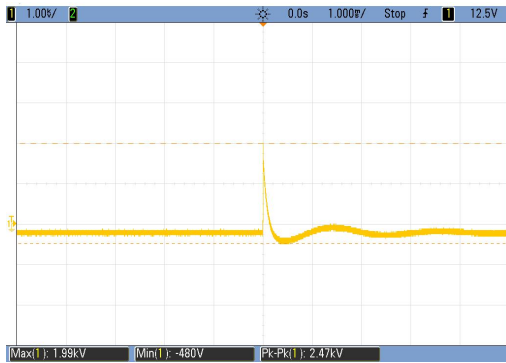

Input voltage waveform (Differential mode 1.99KV)

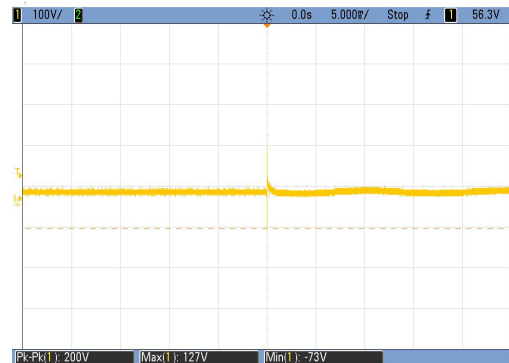

Output voltage waveform (0.12 KV)

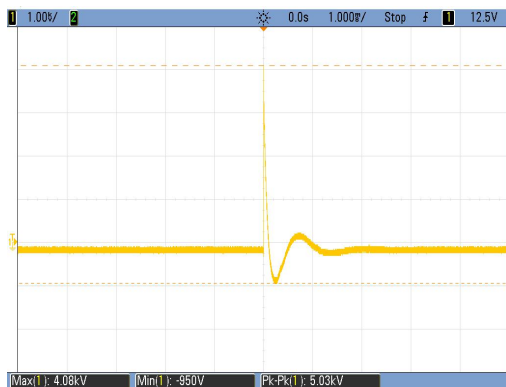

Input voltage waveform (Common mode 4.08KV)

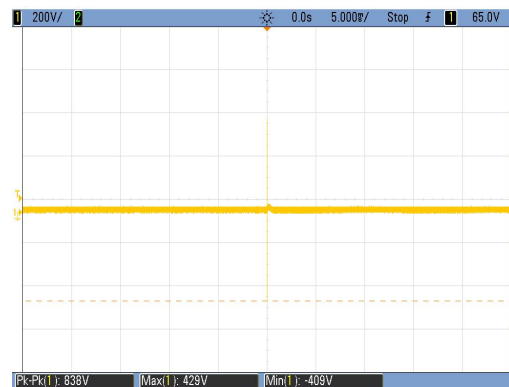

Output voltage waveform(0.42 KV)

Note: The above test results are supporting VRB2405D-10WR2 measured at full load.

② FC-B01D Surge Test Result

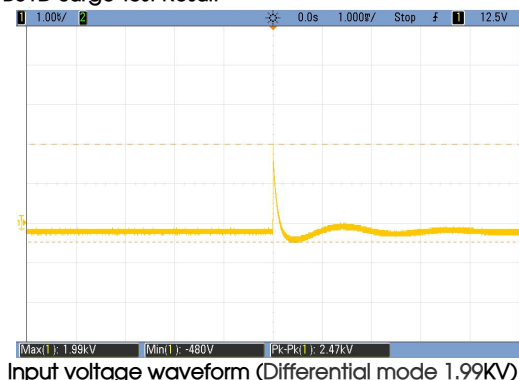

Input voltage waveform (Differential mode 1.99KV)

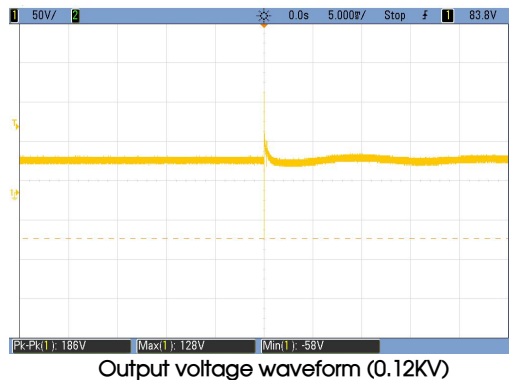

Output voltage waveform (0.12KV)

2018年12月10-正本-

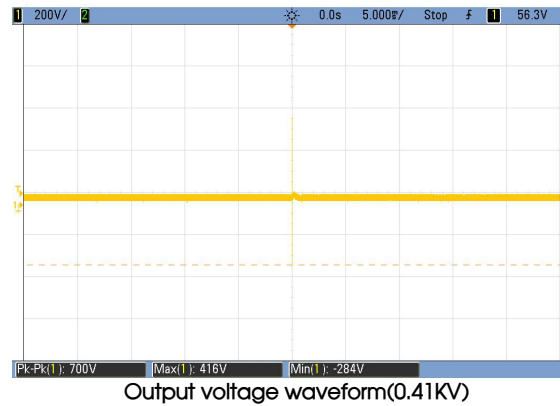
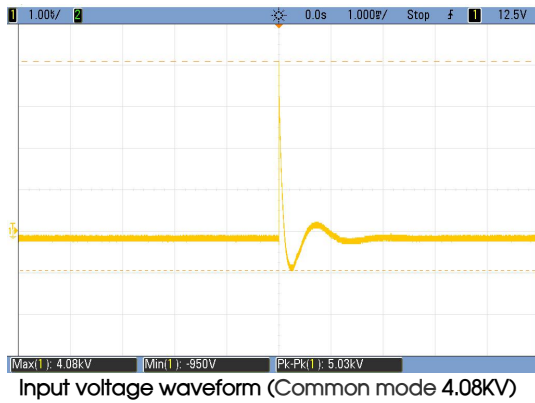

Note: The above test results are supporting VRB4805D-10WR2 measured at full load.

Typical Characteristic Curves

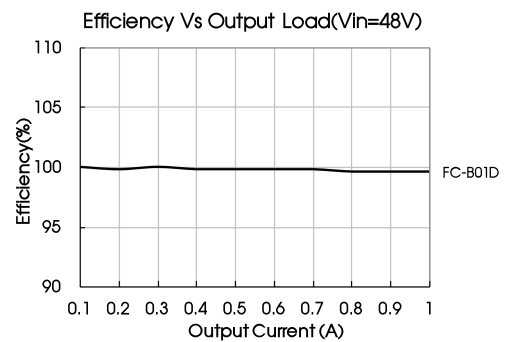
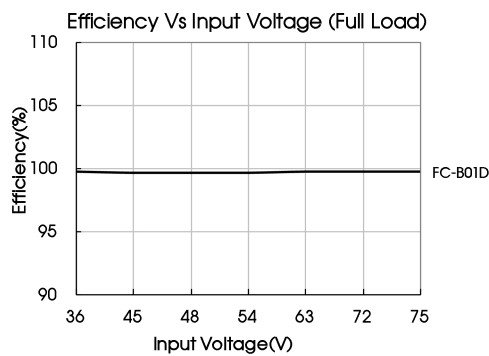
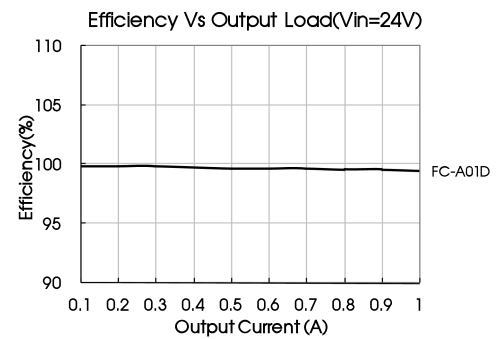
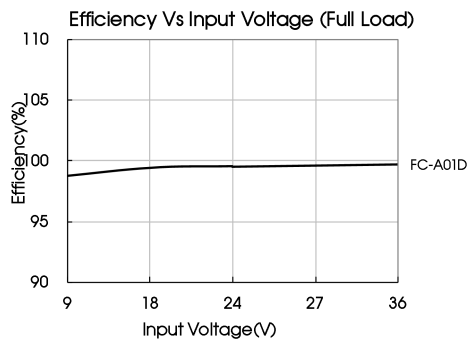

Design Reference

1. Inside schematic

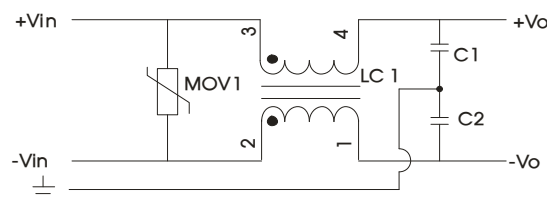

2. Typical application

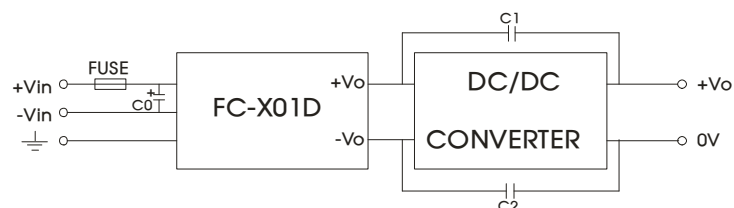

Model	Recommended external circuit parameters
C0	330uF/100V electrolytic capacitor
C1, C2	1000pF/400VAC capacitor
FUSE	The fuse value varies with different power modules and must be selected in accordance with the specified input current of the corresponding power converter, but not exceeding the filter specifications.

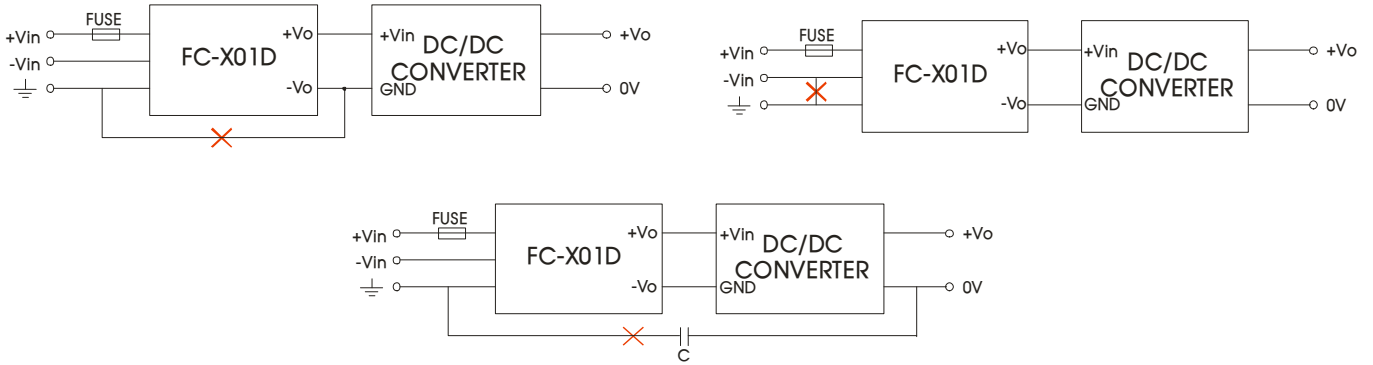

Note: Connections marked with X interfere with this filter modules performance and should therefore not be used

3. For additional information please refer to the application notes on www.mornsun-power.com

FC-A01D & FC-B01D Dimensions and Recommended Layout

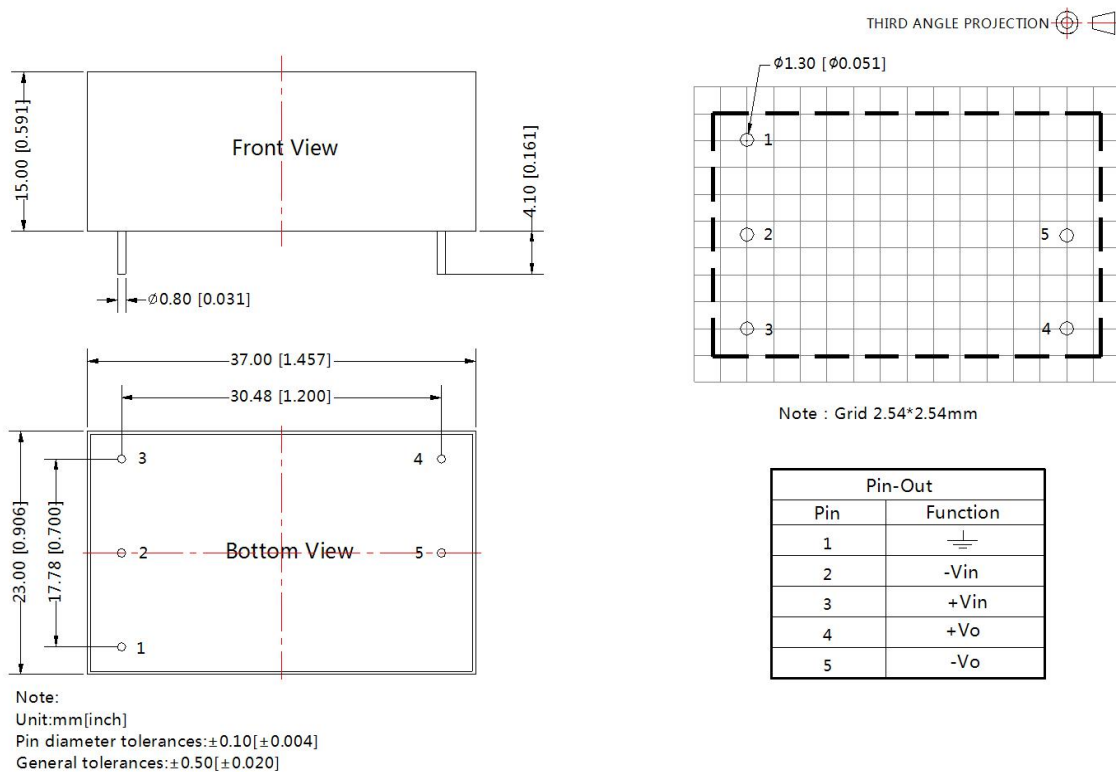

2018年12月10-正本-

FC-A01DA2S & FC-B01DA2S Dimensions

THIRD ANGLE PROJECTION

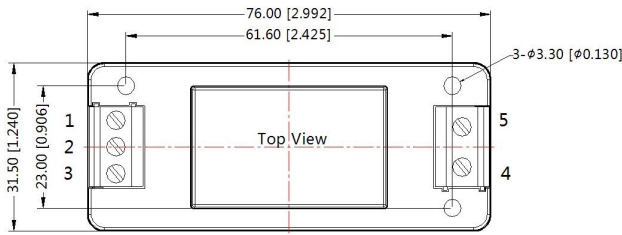

Pin-Out	
Pin	Function
1	⏏
2	-Vin
3	+Vin
4	+Vo
5	-Vo

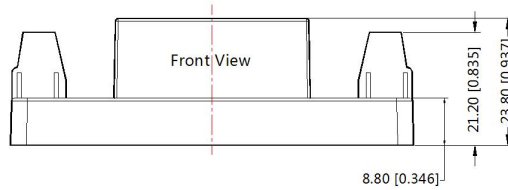

Note:
Unit :mm[inch]
Pin diameter tolerances :±0.10[±0.004]
General tolerances:±0.50[±0.020]

FC-A01DA4S & FC-B01DA4S Dimensions

THIRD ANGLE PROJECTION

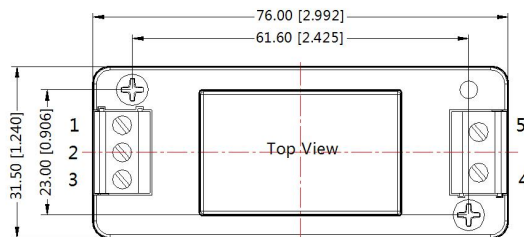

Pin-Out	
Pin	Function
1	⏏
2	-Vin
3	+Vin
4	+Vo
5	-Vo

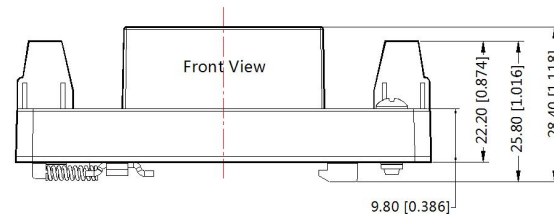

Note:
Unit :mm[inch]
Pin diameter tolerances :±0.10[±0.004]
General tolerances:±0.50[±0.020]

- Note:
- For additional information on Product Packaging please refer to www.mornsun-power.com. The Packaging bag number of Horizontal package: 58220001, the Packaging bag number of A2S/ A4S package: 58220022;
 - Unless otherwise specified, parameters in this datasheet were measured under the conditions of Ta=25°C, humidity<75%RH with nominal input voltage and rated output load;
 - All index testing methods in this datasheet are based on our Company's corporate standards;
 - The performance indexes of the product models listed in this manual are as above, but some indexes of non-standard model products will exceed the above-mentioned requirements, and please directly contact our technicians for specific information;
 - We can provide product customization service, please contact our technicians directly for specific information;
 - Products are related to laws and regulations: see "Features" and "EMC";
 - Our products shall be classified according to ISO14001 and related environmental laws and regulations, and shall be handled by qualified units.

MORNSUN Guangzhou Science & Technology Co., Ltd.

Address: No. 5, Kehui St. 1, Kehui Development Center, Science Ave., Guangzhou Science City, Luogang District, Guangzhou, P. R. China
Tel: 86-20-38601850 Fax: 86-20-38601272 E-mail: sales@mornsun.cn www.mornsun-power.com